

PCT

WORLD INTELLECTUAL PROPERTY ORGANIZATION  
International Bureau



INTERNATIONAL APPLICATION PUBLISHED UNDER THE PATENT COOPERATION TREATY (PCT)

<p>(51) International Patent Classification <sup>6</sup> : G09G 5/00, 5/22, 5/26, G09B 17/00, 5/00</p>	<p>A1</p>	<p>(11) International Publication Number: <b>WO 97/22101</b> (43) International Publication Date: 19 June 1997 (19.06.97)</p>
<p>(21) International Application Number: PCT/US96/19609 (22) International Filing Date: 11 December 1996 (11.12.96) (30) Priority Data: 08/572.407 14 December 1995 (14.12.95) US (71) Applicant: MOTOROLA INC. [US/US]; 1303 East Algonquin Road, Schaumburg, IL 60196 (US). (72) Inventors: HUFFMAN, James; 4 Stegner Lane, Austin, TX 78746 (US). COLLINS, Russell, L.; 11705 Onion Hollow Run, Austin, TX 78739 (US). (74) Agents: INGRASSIA, Vincent, B. et al.; Motorola Inc., Intellectual Property Dept., P.O. Box 10219, Scottsdale, AZ 85271-0219 (US).</p>	<p>(81) Designated States: AM, AT, AU, BB, BG, BR, BY, CA, CH, CN, CU, CZ, DE, DK, EE, ES, FI, GB, GE, HU, IL, IS, JP, KE, KG, KP, KR, KZ, LK, LR, LT, LU, LV, MD, MG, MN, MW, MX, NO, NZ, PL, PT, RO, RU, SD, SE, SG, SI, SK, TJ, TM, TT, UA, UG, UZ, VN, European patent (AT, BE, CH, DE, DK, ES, FI, FR, GB, GR, IE, IT, LU, MC, NL, PT, SE).  Published <i>With international search report. Before the expiration of the time limit for amending the claims and to be republished in the event of the receipt of amendments.</i></p>	

(54) Title: ELECTRONIC BOOK AND METHOD OF SELECTING A PRIMARY FONT AND A PRIMARY SIZE FOR DISPLAYING TEXT THEREWITH

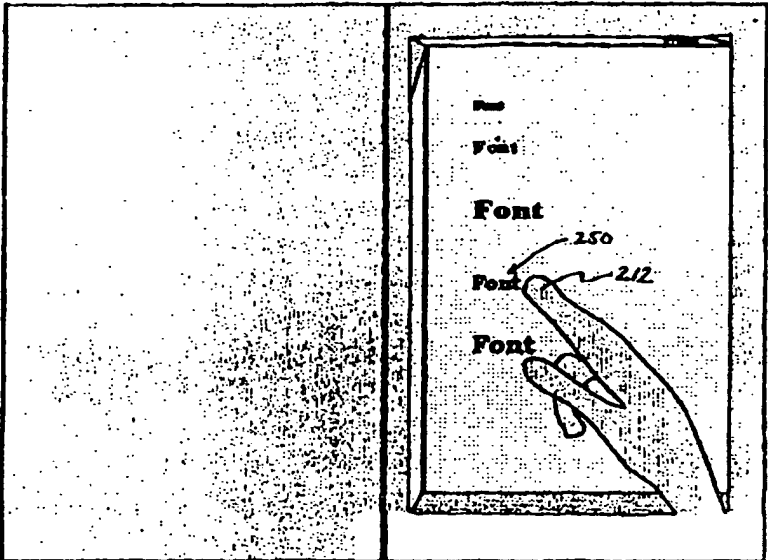

(57) Abstract  
A method of selecting a primary font and a primary size for displaying text in an electronic book (118) having a book-shaped housing (100) includes displaying a plurality of words (250) using a corresponding plurality of combinations of a plurality of fonts and a plurality of sizes. A user-initiated event (212) is received in which one word of the plurality of words (250) is selected. The primary font is updated to a font with which the one word is displayed, and the primary size is updated to a size in which the one word is displayed.

**FOR THE PURPOSES OF INFORMATION ONLY**

Codes used to identify States party to the PCT on the front pages of pamphlets publishing international applications under the PCT.

AM	Armenia	GB	United Kingdom	MW	Malawi
AT	Austria	GE	Georgia	MX	Mexico
AU	Australia	GN	Guinea	NE	Niger
BB	Barbados	GR	Greece	NI	Netherlands
BE	Belgium	HU	Hungary	NO	Norway
BF	Burkina Faso	IE	Ireland	NZ	New Zealand
BG	Bulgaria	IT	Italy	PL	Poland
BJ	Benin	JP	Japan	PT	Portugal
BR	Brazil	KE	Kenya	RO	Romania
BY	Belarus	KG	Kyrgyzstan	RU	Russian Federation
CA	Canada	KP	Democratic People's Republic of Korea	SD	Sudan
CF	Central African Republic	KR	Republic of Korea	SE	Sweden
CG	Congo	KZ	Kazakhstan	SG	Singapore
CH	Switzerland	LJ	Liechtenstein	SI	Slovenia
CI	Côte d'Ivoire	LK	Sri Lanka	SK	Slovakia
CM	Cameroon	LR	Liberia	SN	Senegal
CN	China	LT	Lithuania	SZ	Swaziland
CS	Czechoslovakia	LU	Luxembourg	TD	Chad
CZ	Czech Republic	LV	Latvia	TG	Togo
DE	Germany	MC	Monaco	TJ	Tajikistan
DK	Denmark	MD	Republic of Moldova	TT	Trinidad and Tobago
EE	Estonia	MG	Madagascar	UA	Ukraine
ES	Spain	ML	Mali	UG	Uganda
FI	Finland	MN	Mongolia	US	United States of America
FR	France	MR	Mauritania	UZ	Uzbekistan
GA	Gabon			VN	Viet Nam

0 ELECTRONIC BOOK AND METHOD OF SELECTING A PRIMARY FONT AND  
A PRIMARY SIZE FOR DISPLAYING TEXT THEREWITH

Related Invention

5 The present invention is related to the following  
invention which is assigned to the same assignee as the  
present invention:

"System and Method for Limiting Access to a Book  
Card", having Serial No. 08/572,346, filed December 14,  
10 1995.

"Apparatus and Method for Storing and Presenting  
Text", having Serial No. 08/572,451, filed December 14,  
1995.

"Method and Electronic Book for Creating a Plurality  
15 of Versions of a Book", having Serial No. 08/572,485,  
filed December 14, 1995.

"Electronic Book Diary and Method For Use Therefore",  
having Serial No. 08/572,602, filed December 14, 1995.

"Method and Device for Inhibiting the Operation of an  
20 Electronic Device During Take-Off and Landing of an  
Aircraft", having Serial No. 08/572,603, filed December  
14, 1995.

"System for Inhibiting the Operation of an Electronic  
Device During Take-Off and Landing of an Aircraft", having  
25 Serial No. 08/572,484, filed December 14, 1995.

"Method for Abridging Text", having Serial No.  
08/572,834, filed December 14, 1995.

"A Method of Substituting Names in an Electronic  
Book", having Serial No. 08/572,480, filed December 14,  
30 1995.

"System and Method of Authoring Tools for an  
Electronic Book", having Serial No. 08/572,358, filed  
December 14, 1995.

"System and Method for an Automatic Library for a  
35 Plurality of Book Cards", having Serial No. 08/572,482,  
filed December 14, 1995.

- 0 "Electronic Book and Graphical User Interface for  
Selecting a Book to Read Therewith", having Serial No.  
08/572,406, filed December 14, 1995.
- "Electronic Book and Graphical User Interface to  
Provide Control Thereof", having Serial No. 08/572,403,  
5 filed December 14, 1995.
- "Electronic Book and Method of Storing at Least One  
Book in an Internal Machine-Readable Storage Medium",  
having Serial No. 08/572,593, filed December 14, 1995.
- "Electronic Book and Method of Annotation Therefor",  
10 having Serial No. 08/572,367, filed December 14, 1995.
- "Electronic Book and a Method of Displaying a  
Relative Position of a Current Page of a Book Therefor",  
having Serial No. 08/572,373, filed December 14, 1995.
- "Method and System for Encoding a Book for Reading  
15 Using an Electronic Book", having Serial No. 08/572,468,  
filed December 14, 1995.
- "Electronic Book and Method of Displaying an Animated  
Page Turn Therefor", having Serial No. 08/572,405, filed  
December 14, 1995.
- 20 "Electronic Book and Method of Controlling a Rate of  
Information Displayed Thereby", having Serial No.  
08/572,372, filed December 14, 1995.
- "Reusable Housing and Memory Card Therefor", having  
Serial No. 08/572,413, filed December 14, 1995.
- 25 "Electronic Book and Method of Displaying at Least  
One Reading Metric Therefor", having Serial No.  
08/572,842, filed December 14, 1995.
- "Electronic Book and Method of Creating a Personal  
Log of Reading Activity Therefor", having Serial No.  
30 08/572,456, filed December 14, 1995.
- "Electronic Book Having Highlighting Feature", having  
Serial No. 08/572,469, filed December 14, 1995.
- "Electronic Book and Method of Capturing and Storing  
a Quote Therein", having Serial No. 08/572,601, filed  
35 December 14, 1995.

The subject matter of the above-identified related

0 inventions are hereby incorporated by reference into the  
disclosure of this invention.

#### Field of the Invention

5 The present invention relates to electronic books  
having the look and feel of real paper books and methods  
of selecting a primary font and a primary size for  
displaying text therewith.

#### 10 Background of the Invention

Various types of hand-held electronic reading devices  
have been proposed to electronically display textual  
information for reading by a user. A typical hand-held  
15 electronic reading device includes a display device to  
display the textual information and a user interface which  
allows a user to navigate through the textual information  
and access various features of the electronic reading  
device. The display device and the user interface are  
20 incorporated in a hand-held housing to facilitate  
portability of the electronic reading device.

Many hand-held electronic reading devices have a user  
interface in the form one or more external buttons. The  
buttons are depressed in a predetermined manner either to  
25 navigate through the textual information or to access  
various features of the device. However, many hand-held  
electronic reading devices implement the user interface in  
a manner which does not provide a simple, intuitive, or  
efficient method for navigating the textual information or  
30 for accessing the features.

U.S. Patent No. 5,233,333 to Borsuk discloses a hand-  
held portable reading unit having a button located thereon  
for varying a font size in which the textual information  
is displayed. Depression of the button increments an  
35 internal variable related to the font size. A user  
selects a desired font size by repeatedly depressing the

0 font size select button until the desired font size is  
displayed on the reading unit. Consequently, the user  
must cycle through a number of font sizes until arriving  
at the desired font size.

5 The lack of simplicity of using current hand-held  
electronic reading devices along with the lack of comfort  
in handling many of these devices result in some people  
preferring to read a real paper book rather than using a  
hand-held electronic reading device.

#### 10 Brief Description of the Drawings

The invention is pointed out with particularity in  
the appended claims. However, other features of the  
invention will become more apparent and the invention will  
15 be best understood by referring to the following detailed  
description in conjunction with the accompanying drawings  
in which:

FIG. 1 is a view of an embodiment of an electronic  
book in a closed position;

20 FIG. 2 is a view of the embodiment of the electronic  
book of FIG. 1 in an open position;

FIG. 3 is a block diagram of an embodiment of the  
electronic book;

25 FIG. 4 is an illustration of various hot spot  
locations used to provide control of the electronic book  
to a user;

FIG. 5 is an illustration of a library screen display  
using an embodiment of the electronic book;

30 FIG. 6 is an illustration of a user-initiated event  
to open the desired book from the library screen;

FIG. 7 is an illustration of a first page of a book  
displayed on an embodiment of the electronic book;

FIG. 8 is an illustration of a title page of a book  
displayed on an embodiment of the electronic book;

35 FIG. 9 is an illustration of a font selection page  
displayed on an embodiment of the electronic book;

0           FIG. 10 is an illustration of the title page of the book which is displayed upon exiting the font selection page;

          FIG. 11 is an illustration of a system control page displayed in an embodiment of the electronic book;

5           FIG. 12 is an illustration of the title page of the book which is displayed upon exiting the system control page;

          FIG. 13 is an illustration of the title page of the book wherein a radio frequency link option is selected;

10          FIG. 14 is an illustration of the title page of the book wherein a pacing control option is selected by a user;

          FIG. 15 is an illustration of a pacing control page displayed in an embodiment of the electronic book;

15          FIG. 16 is an illustration of the title page of the book which depicts other user-initiated options;

          FIG. 17 is an illustration of a page marked by a dog ear for use in embodiments of the electronic book;

20          FIG. 18 is an illustration of a dog ear dialog box used in embodiments of the electronic book;

          FIG. 19 is an illustration of a user selecting a portion of a page of text;

          FIG. 20 is an illustration of an option selection dialog box used in embodiments of the electronic book;

25          FIG. 21 is an illustration of an annotation display used in embodiments of the electronic book;

          FIG. 22 is an illustration of a marker used to indicate that a page has an annotation associated therewith;

30          FIG. 23 is an illustration of a user selecting a set bookmark option in the option selection dialog box;

          FIG. 24 is an illustration of the page of FIG. 23 having a bookmark displayed thereon;

35          FIG. 25 is a flow diagram of an event loop performed in an embodiment of the electronic book;

          FIG. 26 is a flow diagram of steps performed in an

0 embodiment of a library graphical user interface routine  
for use in the electronic book;

FIGS. 27 and 28 show flow diagrams of an embodiment  
of the routine to display pages of text in the electronic  
book;

5 FIG. 29 is a flow diagram of steps performed to  
display a current page in the electronic book;

FIG. 30 is a flow diagram of steps performed in an  
embodiment of an annotation subroutine;

10 FIG. 31 is a flow diagram of steps performed in an  
embodiment of a quote capture subroutine;

FIG. 32 is a flow diagram of steps performed in an  
embodiment of a dog ear subroutine;

FIG. 33 is a flow diagram of steps performed in an  
embodiment of a pacing control subroutine;

15 FIG. 34 is a flow diagram of steps performed in an  
embodiment of the font selection subroutine; and

FIG. 35 is a flow diagram of steps performed in an  
embodiment of the system control subroutine.

## 20 Detailed Description of a Preferred Embodiment

Embodiments of the present invention advantageously  
provide an electronic book having an improved method of  
selecting a primary font and a primary size for displaying  
25 textual information therewith. A user selects a desired  
font/size combination by viewing a plurality of words  
displayed in a plurality of font/size combinations, and  
selecting the desired font/size combination directly  
therefrom. The primary font and the primary size are  
30 automatically updated upon selecting the desired font/size  
combination.

FIG. 1 is a view of an embodiment of an electronic  
book in a closed position. The electronic book has a  
book-shaped housing 100 having the look and feel of a  
35 real, paper book. The book-shaped housing 100 has a first  
housing member 102 pivotably connected to a second housing



0 member 104 to facilitate opening and closing in a book-  
like manner. The first housing member is partially formed  
by a book-like, front cover member 106. In a similar  
manner, the second housing member 104 is partially formed  
by a book-like, back cover member 108. The front cover  
5 member 106 and the back cover member 108 are pivotably  
connected by a spine member 110.

To better provide the look and feel of a real book,  
the front cover member 106 and the back cover member 108  
have an exterior made of a material used in real book  
10 covers. Examples of such a material include, but are not  
limited to, leather, simulated leather, vinyl, and a woven  
fabric such as cotton. The exterior can either be  
permanently affixed to the front cover member 106 and the  
back cover member 108, or be in the form of a removable  
15 jacket.

In addition to the front cover member 106, the first  
housing member 102 is partially defined by an enclosure  
112. Similarly, the second housing member 104 is  
partially defined by an enclosure 114 in addition to the  
20 back cover member 108. When the electronic book is in the  
closed position, the enclosure 112 and the enclosure 114  
have an external appearance of edges of pages of a real,  
paper book. In particular, the enclosures 112 and 114  
define a top edge 116, a bottom edge 118, and a foredge  
25 120 which appear as the top edge, the bottom edge, and the  
foredge, respectively, of a real, paper book. The top  
edge 116, the bottom edge 118, and the foredge 120 are  
recessed with respect to the front cover member 106 and  
the back cover member 108.

30 FIG. 2 is a view of the embodiment of the electronic  
book of FIG. 1 in an open position. It is preferred that  
the first housing member 102 and the second housing member  
104 be substantially symmetric so that the front cover  
member 106, the back cover member 108, and the spine  
35 member 110 rest substantially flat on a flat surface in  
the open position. The substantial symmetry makes the

0 electronic book feel like a real, paper book being opened  
to one of its middle pages. As a result, the electronic  
book can be comfortably held and read in a manner  
consistent with a paper book.

5 A touchscreen 130 is integrated in the book-shaped  
housing 100 to be accessible when the book-shaped housing  
100 is opened in the book-like manner. In the embodiment  
illustrated in FIG. 2, the touchscreen 130 is integrated  
with the enclosure 114 of the second housing member 104.  
Optionally, a second touchscreen 132 can also be  
10 integrated in the book-shaped housing. As illustrated,  
the second touchscreen 132 can be integrated with the  
enclosure 112 of the first housing member 102.

The touchscreen 130 and the second touchscreen 132  
each include a touch-sensitive panel over a display  
15 device. Behind the display device can be a backlighting  
element.

The touchscreen 130 and the second touchscreen 132  
may provide either a color display or a monochrome display  
depending on a particular model of the electronic book.  
20 To provide their touch sensitivity, the touchscreen 130  
and the second touchscreen 132 can utilize analog  
resistive technology as is known in the art. It is noted,  
however, that other technologies for providing touch  
sensitivity can also be utilized.

25 It is preferred that the touchscreen 130 and the  
second touchscreen 132 be capable of providing  
backlighting to allow use of the electronic book in  
poorly-lit or dimly-lit environments. More preferably,  
the touchscreen 130 is capable of backlighting selected  
30 portions or subsets of the entire touchscreen 130. Here,  
the electronic book can provide a power-saving mode  
wherein only a portion of the touchscreen 130 being viewed  
by a user is actively backlit.

The book-shaped housing includes a receiving slot 134  
35 which physically receives a removable machine-readable  
storage medium 136. The removable machine-readable

0 storage medium 136 contains machine-readable data  
representative of text from a book. Optionally, the  
machine-readable data is also representative of graphical  
information within the book. It is noted that the term  
"book" should be construed broadly as any written or  
5 printed composition having textual information which is  
read by an individual. Hence, the term "book" should be  
inclusive of books, magazines, newspapers, or the like.

The text and the graphical information contained in  
the removable machine-readable storage medium 136 are  
10 displayed on the touchscreen 130. The second touchscreen  
132 can be included to display graphical information while  
the touchscreen 130 displays text. As another option, the  
touchscreen 130 and the second touchscreen 132 can display  
neighboring pages of the book. Further, the touchscreen  
15 130 and the second touchscreen 132 can be utilized to  
simultaneously view two books. The second touchscreen 132  
can also be utilized in a second level operating system,  
which is herein called an advanced reader graphical user  
interface. The functionality of the second touchscreen  
20 132 can be selected by the user using a switch or the  
advanced reader graphical user interface in the electronic  
book.

It is noted that there are a number of ways to encode  
the text and the graphical information within the book for  
25 storage on the removable machine-readable storage medium  
136. In one embodiment, the removable machine-readable  
storage medium 136 contains a series of pointers which  
point to words contained in a dictionary within the  
electronic book. Words which are not contained in the  
30 dictionary are located in a customized dictionary on the  
removable machine-readable storage medium 136. In this  
way, the words to be presented on the touchscreen 130 are  
selected with minimal storage requirements in the  
removable machine-readable storage medium 136.

35 Preferably, the removable machine-readable storage  
medium 136 is in the form of either a smart card or a

0 PCMCIA card. Here, the receiving slot 134 is shaped to receive either a smart card or a PCMCIA card.

The book-shaped housing 100 further defines a power-receiving port 138 and a data-receiving port 140. The power-receiving port 138 receives a plug or other type of  
5 connector to supply power to the electronic book. Power supplied to the electronic book via the power receiving port 138 can be used to directly operate the electronic book or to recharge batteries internal to the electronic book. In one embodiment of the electronic book, the spine  
10 member 110 is shaped to receive a combination of battery cells which can be recharged via the power-receiving port 138. If the second touchscreen 132 is not used, the enclosure 112 of the first housing member 102 can be used to store extra batteries and/or extra book cards.

15 The data port 140 is utilized to communicate signals representative of machine-readable data between the electronic book and an external device. The data port 140 can be used, for example, to receive machine-readable data signals representative of text and graphics in a book from  
20 the external device for storage in the electronic book. In this manner, the data port 140 provides an alternative to the receiving slot 134 for receiving text and graphics of a book. Additionally, the data port 140 can be  
25 utilized to transmit machine-readable data contained within the electronic book to the external device.

Preferably, the electronic book is automatically activated (i.e., automatically turns on) when in the open position, and is automatically deactivated (i.e.,  
automatically turns off) when in the closed position. To  
30 this end, the electronic book can include a magnet 142 incorporated within or of the first housing member 102 or the second housing member, and a reed switch 144 incorporated within the other housing member. When the electronic book is in the closed position, the magnet 142  
35 is proximate to the reed switch 144. The magnetic field generated by the magnet 142 causes the reed switch 144 to

0 assume a first switch position which deactivates the  
electronic book. When the electronic book is in the open  
position, the magnet 142 is distant from the reed switch  
144. In absence of a significant magnetic field, the reed  
switch 144 returns to a second switch position which  
5 activates the electronic book.

It is noted that in alternative embodiments, the  
electronic book is activated and deactivated by an  
external switch or button (not specifically illustrated)  
rather than by the reed switch 144.

10 FIG. 3 is a block diagram of an embodiment of the  
electronic book. An interface 150 receives the removable  
machine-readable storage medium 136 containing machine-  
readable data representative of text and graphics from a  
book. In a preferred embodiment of the present invention,  
15 the interface 150 comprises a PCMCIA interface which  
receives a removable machine-readable storage medium in  
the form of a PCMCIA card. Physically, the interface 150  
is proximate to the receiving slot 134 illustrated in FIG.  
2.

20 In general, it is preferred that the interface 150 be  
capable of receiving an external device other than a  
machine-readable storage medium. Further, it is preferred  
that the interface 150 be capable of receiving a plurality  
of external devices. To these ends, the interface 150 can  
25 comprise a plurality of similar interfaces, such as a  
plurality of PCMCIA interfaces. Here, the electronic book  
can simultaneously receive two or more of a PCMCIA memory  
card, a PCMCIA modem, or another PCMCIA device.

A processor 152 is in communication with the  
30 interface 150 to read the machine-readable data from the  
removable machine-readable storage medium 136. The  
processor 152 can be in the form of a microprocessor, a  
custom integrated circuit, an application specific  
integrated circuit, or a programmable logic array, for  
35 example. Physically, the processor 152 is housed within  
the book-shaped housing 100.

0           The touchscreen 130 is in communication with the  
processor 152 to display a page of the text and/or the  
graphics represented by the machine-readable data.  
Further, the touchscreen 130 acts as an input device to  
receive user-initiated events, i.e. user-initiated  
5           actions, and communicate these user-initiated events or  
actions to the processor 152.

          An internal machine-readable storage medium 154 is in  
communication with the processor 152 to support a number  
of operative features of the electronic book. The  
10           internal machine-readable storage medium 154 can include  
one or more memory devices, such as a random access  
memory, a read-only memory, and/or an electronically  
erasable and programmable read-only memory (EEPROM).

          A computer program or other form of software or  
15           firmware is stored in the internal machine-readable  
storage medium 154. The computer program directs the  
processor 152 to support the operative features of the  
electronic book. Preferably, the computer program  
includes an event loop that processes and responds to  
20           user-initiated events and actions. More specifically,  
received events are placed in an event queue in the  
internal machine-readable storage medium 154. Each of the  
received events is processed and removed from the event  
queue. As a result, a user can initiate a number of  
25           events or actions without having to wait for previous  
actions to be processed.

          The internal machine-readable storage medium 154 can  
also include a dictionary to which pointers stored in the  
removable machine-readable storage medium 136 point. By  
30           including the dictionary within the electronic book, less  
storage space is required on the removable machine-  
readable storage medium 136 to store the text from the  
book.

          Further, the internal machine-readable storage medium  
35           154 can contain machine-readable data representative of  
text and graphics from a book. Here, the processor 152

0 reads the machine-readable data from the internal machine-readable storage medium 154 and commands the touchscreen 130 to display pages of the text and graphics.

Signals are communicated between the electronic book and an external device via either a data interface 156 in  
5 communication with the processor 152, via an antenna 158 and a radio frequency modem 160 in communication with the processor 152, or via an infrared transceiver 161 in communication with the processor. As another option, communication between the electronic book and the external  
10 device can be effectuated using either a smart communication card or a PCMCIA communication card received by the interface 150. Here, a PCMCIA modem card or a PCMCIA infrared transceiver card can be utilized, for example, for external communication.

15 Optionally, a voice synthesizer 162 is included in the electronic book to provide a spoken auditory display of pages of the text read from either the removable machine-readable storage medium 136 or the internal machine-readable storage medium 154. In one embodiment,  
20 the processor 152 directly converts the text from the book into speech signals for the voice synthesizer 162. Optionally, control codes can be provided within the removable machine-readable storage medium 136 to allow words to be pronounced or emphasized in different ways.  
25 Further, the control codes can command the words to be spoken in either a male voice, a female voice, or a child's voice. The synthesized voice can be sampled (such as using the user's voice) or can be a computer-synthesized voice.

30 As an alternative, a custom voice dictionary can be provided to augment a general voice dictionary stored in the electronic book. The customized voice dictionary can be used for alternative pronunciations, voices, and emphasis.

35 The voice synthesizer 162 is either permanently integrated in the electronic book or is a removable

0 accessory. To facilitate removability, the voice  
synthesizer 162 can be embodied within a smart card or a  
PCMCIA card for reception by the interface 150.  
Alternatively, the voice synthesizer 162 can communicate  
with the processor 152 via an accessory interface bus 163.  
5 In a similar manner, the RF modem 160 and/or the second  
touchscreen 132 can communicate with the processor 152 via  
the accessory interface bus 163.

Before giving a detailed description of steps  
performed by the elements of FIG. 3 for the various  
10 embodiments of the present invention, a functional  
description of a particular embodiment of the electronic  
book will now be described. This embodiment is based on a  
single touchscreen, namely the touchscreen 130, to display  
the text and the graphics of the book and to allow a user  
15 to control the electronic book. It is noted, however,  
that the teachings herein can also be applied to a dual  
touchscreen embodiment which further includes the second  
touchscreen 132. Furthermore, it is noted that the  
teachings herein are not limited to the use of a  
20 touchscreen, and hence, can be applied to an electronic  
book containing any type of display device (such as a  
liquid crystal display or a cathode ray tube, for example)  
and any type of input device (such as a series of buttons,  
a mouse, a trackball, a lightpen, or a touchpad, for  
25 example).

FIG. 4 is an illustration of various hot spot  
locations used to provide control of the electronic book  
to a user. A page of the text represented by the machine-  
readable data read from either the removable machine-  
30 readable storage medium 136 or the internal machine-  
readable storage medium 154 is displayed on a display  
portion 168 of the touchscreen 130. The display portion  
168 is also utilized to display graphics represented by  
the machine-readable data.

35 A first hot spot portion 170 of the touchscreen 130  
is designated for receiving a predetermined user-initiated



0 event which requests that a subsequent page of the text be  
displayed on the touchscreen 130. Hence, the first hot  
spot portion 170 can be synonymously referred to as an  
"advance page portion" or an "advance page hot spot" for  
receiving an advance page event. In the embodiment  
5 illustrated in FIG. 4, the first hot spot portion 170  
includes a top margin portion 172, a side margin portion  
174, and a bottom margin portion 176 of the touchscreen  
130. The top margin portion 172 is located above the  
display portion 168, the side margin portion 174 is  
10 located beside the display portion 168, and the bottom  
margin portion 176 is located below the display portion  
168.

A second hot spot portion 178 of the touchscreen 130  
is designated for receiving a predetermined user-initiated  
15 event which requests that a previous page of the text be  
displayed. Hence, the second hot spot portion 178 can be  
synonymously referred to as a "page back portion" or a  
"page back hot spot" for receiving a page back event. In  
the embodiment illustrated in FIG. 4, the second hot spot  
20 portion 178 is located beside the display portion 168 of  
the touchscreen 130 and opposite the side margin portion  
174.

A third hot spot portion 180 of the touchscreen 130  
is designated for receiving a predetermined user-initiated  
25 event which requests that a pre-marked page be displayed  
on the touchscreen 130. In the embodiment of FIG. 4, the  
third hot spot portion 180 is located in an upper portion  
of the touchscreen 130 and is shaped as a bookmark graphic  
182. Hence, the third hot spot portion 180 can be  
30 synonymously referred to as a "bookmark portion" or a  
"bookmark hot spot".

A fourth hot spot portion 184 of the touchscreen 130  
is designated for receiving a predetermined user-initiated  
event to close the current book being read and to request  
35 that a library screen be displayed on the touchscreen 130.  
The library screen is utilized by a user to select a book

0 to read from a plurality of books within a library.  
Hence, the fourth hot spot portion 184 can be synonymously  
referred to as a "close book portion" or a "close book hot  
spot" for receiving a close book event.

5 A fifth hot spot portion 186 of the touchscreen 130  
is designated for receiving a predetermined user-initiated  
event which requests that the displayed page be marked.  
In the embodiment of FIG. 4, the fifth hot spot portion  
186 is located in an upper corner of the touchscreen 130.  
10 In this embodiment, the fifth hot spot portion 186 of the  
touchscreen 130 is utilized for dog-earring pages of the  
book. Hence, the fifth hot spot portion 186 can be  
synonymously referred to as a "dog ear portion" or a "dog  
ear hot spot" for receiving a dog ear event.

15 A sixth portion 188 of the touchscreen 130 is  
designated to provide a depth indication representative of  
how much of the book is left to be read. In the  
embodiment illustrated in FIG. 4, the sixth portion 188 is  
located above the display portion 168. The second hot  
spot portion 178 can be utilized in conjunction with the  
20 sixth portion 188 to provide the depth indication.

In the embodiment of FIG. 4, the display portion 168,  
the first hot spot portion 170, the second hot spot  
portion 178, the third hot spot portion 180, the fourth  
hot spot portion 184, and the fifth hot spot portion 186  
25 are mutually exclusive (i.e. non-overlapping) portions of  
the touchscreen 130. However, in alternative embodiments  
of the present invention, these portions may not be  
mutually exclusive, and hence may overlap. Further, some  
embodiments of the present invention may utilize different  
30 sizes and positions for the above-described hot spot  
portions.

Preferably, the hot spot portions are motion  
sensitive so that a touch event, a touch-and-hold event,  
and a drag event can be sensed to initiate differing  
35 responses. For example, a page back event can be received  
in the form of a flipping motion (i.e. a short stroke)

0 across the second hot spot portion 178.

FIG. 5 is an illustration of a library screen displayed using an embodiment of the electronic book. In a preferred embodiment, the library screen is displayed upon opening the electronic book or activating the  
5 electronic book. The library screen includes a rearward graphical book representation 200 having a graphical spine portion 202. A forward graphical book representation 204 is displayed in front of the rearward graphical book representation 200. The forward graphical book  
10 representation 204 has a graphical spine portion 206 and a graphical front cover portion 208. A title 210 of a book currently being read is displayed on the forward graphical book representation 204. In the embodiment illustrated in  
15 FIG. 5, the title 210 is displayed on the graphical spine portion 206 of the forward graphical book representation 204.

Upon receiving a user-initiated event in which a portion of the rearward graphical book representation 200 is selected, a title of another book or books of a  
20 plurality of books in a library is displayed in place of the title 210 on the forward graphical book representation 204. In a preferred embodiment, the portion of the rearward graphical book representation 200 selected in this user-initiated event is within the graphical spine  
25 portion 202.

The titles of the books in the library can be obtained from a storage medium (which contains the books) installed in the electronic book. Alternatively, the titles of the books can be obtained by a connection to an  
30 information service providing books or other information in real time. As another alternative, the titles and the books can be accessed on demand from a world-wide web page.

A user can scroll through the library of books by  
35 repeatedly touching the spine portion 202 with his or her finger 212 until a desired book title is pulled into view.

0 When the spine portion 202 is selected for a last of the plurality of books, the title of the first book is displayed. In this manner, the user can rotate through the library of books until a desired book is in front.

5 FIG. 6 is an illustration of a user-initiated event to open the desired book from the library screen. The forward book is opened upon receiving a user-initiated event in which a portion of the forward graphical book representation 204 is selected. This user-initiated event can include, for example, the user touching the front  
10 cover portion 208 of the forward graphical book representation 204 using his or her finger 212. In response to this user-initiated event, the book indicated by a title 214 is opened. If the book is previously unread, the book is opened to page one. If the book has  
15 been read before, the book opens to a page which was last read.

FIG. 7 is an illustration of a first page of a book displayed on the touchscreen 130 upon exiting the library screen. To display the first page of the book, the  
20 machine-readable data representative of text and graphics from the book is read from either the removable machine-readable storage medium 136 installed in the electronic book, or from the internal machine-readable storage medium 154. Upon reading the machine-readable data, a page of  
25 the text and/or the graphics is then displayed on the touchscreen 130. As shown, the text is displayed to appear as a standard page in a real book.

If a user-initiated event is received in which a user selects the second hot spot portion 178, i.e. the page  
30 back portion, of the touchscreen 130 when the book is on the first page, then a title page containing system controls is displayed.

FIG. 8 is an illustration of a title page of a book displayed on an embodiment of the electronic book.  
35 Information which is displayed on the title page includes a book title 220, author information 222, copyright

0 information 224, a Library of Congress number 226, and  
publisher information 228. Also displayed are statistics  
such as a total number of pages 230 in the book, a number  
of pages left to be read 232, and an elapsed reading time  
234.

5 A number of control options are also displayed.  
These control options include, but are not limited to, a  
pacing control option 236, a font selection option 238, a  
system control option 240, a read-to-me option 242, and a  
radio frequency (RF) link option 244. Any of these  
10 control options can be initiated by a respective user-  
initiated event indicative of a user selecting the option.  
As illustrated in FIG. 8, a user is initiating a font  
selection routine by touching the font selection option  
238 using his or her finger 212.

15 FIG. 9 is an illustration of a font selection page  
displayed on an embodiment of the electronic book. The  
font selection page is displayed upon an initiation of the  
font selection routine.

20 Displayed on the font selection page are a number of  
font/size combination options. Each option is in the form  
of a word displayed using a specific font and a specific  
size in accordance with the font/size combination. A user  
selects a desired font/size combination by viewing how  
words appear in the various combinations, and selecting  
25 the combination which is desired. For example, in FIG. 9,  
the user is selecting a desired font/size combination by  
selecting a word 250 displayed in the desired font/size  
combination using his or her finger 212.

30 The fonts can be selected from internal fonts and  
custom fonts provided on the medium provided by a  
publisher. For example, a user may select a Gothic font  
provided on a medium containing a Shakespeare work  
instead of default fonts (e.g. Courier, Helvetica, Avant  
Garde) within the electronic book.

35 Upon selecting the desired font/size combination, the  
electronic book automatically flips back to the title page

0 containing the system controls. Thereafter, the  
electronic book uses the desired font/size combination as  
a primary font/size combination to display the text of the  
book. Titles and headings in the book are enlarged and  
bolded based upon the primary font/size combination.  
5 Other portions of text can be italicized based on the  
primary font. However, it is preferred that the body of  
the text never be displayed smaller than the size selected  
in the primary font/size combination. In some  
embodiments, it may be preferred to display footnotes in a  
10 size smaller than the size selected.

FIG. 10 is an illustration of the title page of the  
book which is displayed upon exiting the font selection  
page. Here, a user is shown to initiate a system control  
routine by selecting the system controls option 240 using  
15 his or her finger 212.

FIG. 11 is an illustration of a system control page  
displayed in an embodiment of the electronic book. The  
system control page is displayed upon executing the system  
control routine.

20 The system control page provides a number of display  
controls including a contrast control 254, a tint control  
256, and a color control 258. Each of these controls  
provides a discrete number of control values which can be  
directly selected by a user. Further, each control value  
25 is displayed in a graphical manner consistent with the  
result of its selection. For example, the contrast  
control 254 includes a high contrast graphical  
representation 262, an intermediate contrast graphical  
representation 264, and a low contrast graphical  
30 representation 266. The graphical representations 262,  
264, and 266 are of the same graphical image, but are  
displayed using different contrast control values. Hence,  
a user can visually determine a desired contrast by  
viewing the graphical representations 262, 264 and 266.  
35 In a similar manner, the tint control 256 and the color  
control 258 each display a predetermined graphical image

0 using a discrete number of tint control values and color  
control values, respectively.

Preferably, the display of the graphical  
representations within the display controls are unaffected  
by current values of selected ones of the controls. In  
5 one preferred embodiment, the display of the graphical  
representations is independent of all of the current  
values. For example, the display of the low contrast  
representation 266 can be independent of the current  
contrast control value, the current tint control value,  
10 and the current color control value. In another preferred  
embodiment, the display of the graphical representations  
in each control is independent of the current value of  
that control, but depend on the current value of the other  
controls. Here, for example, the display of the low  
15 contrast representation 266 is independent of the current  
contrast control value, but dependent upon the current  
tint control value and the current color control value.  
Using either of these two embodiments, a user can  
immediately determine a result of each control value  
20 selection before actually performing the selection.

The system control page also includes a sound control  
267. The sound control 267 is illustrated to have a  
discrete number of sound intensity values which can be  
selected by a user. In the embodiment of FIG. 11, the  
25 sound intensity values are monotonically related to the  
size of an ear displayed on the sound control 267. An ear  
268 having a slash therethrough is indicative of an option  
to turn off the sound. For the purpose of illustration,  
FIG. 11 shows a user selecting an intermediate sound  
30 intensity by touching an ear graphic 269. The user then  
returns to the system control page by touching the second  
hot spot portion 178, i.e. the page back hot spot, of the  
touchscreen 130.

It is noted that the controls on the system control  
35 page can provide continuous, rather than discrete, control  
of the control values in alternative embodiments of the

0 electronic book. Here, for example, the ear size and the  
volume can increase or decrease based on finger selection  
movement.

A pad area 270 of the system control page is utilized  
for testing motions such as a hold event, a turn event,  
5 and a mark event. In particular, a user can point to any  
of a hold selection 271, a turn selection 272, and a mark  
selection 273, and then perform the selected motion in the  
pad area 270. Here, a length of hold time or style of  
dragging a finger for a flip command can be gauged for  
10 each user, for example, using the pad area 270.

FIG. 12 is an illustration of the title page of the  
book which is displayed upon exiting the system control  
page. Here, the user is illustrated to select the read-  
to-me option 244 which initiates the voice synthesizer 162  
15 to audibly read the text being visually displayed on the  
touchscreen 130. The audible reading of the text begins  
at the last page which was displayed on the touchscreen  
130. The reading rate and other controls for the read-to-  
me routine is provided on a pacing control page described  
20 hereinafter.

FIG. 13 is an illustration of the title page of the  
book wherein a radio frequency link option is selected.  
This option is selected by the user by touching the RF  
link option 244 using his or her finger 212. Upon  
25 selecting the RF link option 244, an RF link routine is  
executed. The RF link routine allows the user to download  
updates of the text to the electronic book, and/or to  
interface the electronic book to a personal computer or  
communication unit. The RF link routine utilizes the  
30 antenna 158 and the RF modem 160 illustrated in FIG. 3 to  
communicate with the personal computer using a local  
wireless link, or more generally to communicate with a  
wireless data communication network. Utilizing a  
nationwide wireless data communication network, such as  
35 the Ardis network, allows individuals to receive book  
updates via radio frequency links in major cities.



0           FIG. 14 is an illustration of the title page of the  
book wherein a pacing control option is selected by a  
user. Specifically, the user is shown to initiate a  
pacing control routine by selecting the pacing control  
option 236 displayed on the title page using his or her  
5   finger 212.

          FIG. 15 is an illustration of a pacing control page  
displayed in an embodiment of the electronic book. The  
pacing control page is displayed once the user selects the  
pacing control option 236 from the title page. The pacing  
10   control page includes a display 280 of a current reading  
pace of the user. Based upon the number of pages left in  
the book, which is given in a display 282, a display 284  
of an estimated completion time for the book is also  
given. In the embodiment of FIG. 15, the current reading  
15   pace, the number of pages left, and the estimated  
completion time are displayed in the form of one or more  
sentences.

          Also displayed on the pacing control page is a  
display 290 of a desired reading pace. A display 292 of  
20   an estimated completion time in accordance with the  
desired reading pace is also given. The desired reading  
pace is controlled by the user using a graphical slider  
bar 294. The pages of the text in the book are  
automatically paced by a pacing routine which is enabled  
25   and disabled by a graphical switch 296. In one  
embodiment, each page of text is displayed for a duration  
commensurate with the desired reading rate controlled by  
the graphical slider bar 294. The user returns to the  
title page from the pacing control page by selecting the  
30   second hot spot portion 178, i.e. the page back portion,  
of the touchscreen 130.

          FIG. 16 is an illustration of the title page of the  
book which depicts other user-initiated options. The user  
can return to a book-marked page by selecting the bookmark  
35   graphic 182. The user can return to the library screen by  
selecting the fourth hot spot portion 184, i.e. the close

0 book portion, of the touchscreen 130. The user can go to  
the first page of the book by selecting the first hot spot  
portion 170, i.e. the advance page portion, of the  
touchscreen 130.

5 FIG. 17 is an illustration of a page marked by a dog  
ear in an embodiment of the electronic book. The user  
initiates a dog ear command by performing a predetermined  
user-initiated event. An example of such an event  
includes a user touching an upper corner portion of the  
touchscreen 130, such as the fifth hot spot portion 186  
10 defined earlier.

If the page is not dog-eared, then a brief touching  
of the upper corner portion 186 causes a dog ear graphic  
300 to be displayed in the upper corner portion. In  
addition, an indication that this page has been dog-eared  
15 is stored either in the removable machine-readable storage  
medium 136 or the internal machine-readable storage medium  
154.

If the user touches the upper corner portion 186 of a  
page already marked with a dog ear, or if the upper corner  
20 portion 186 is held for a duration greater than a  
predetermined threshold, then a dog ear dialog box is  
opened.

FIG. 18 is an illustration of a dog ear dialog box  
used in embodiments of the electronic book. A dog ear  
25 dialog box 302 is displayed on touchscreen 130. The dog  
ear dialog box 302 displays a list 304 of all dog-eared  
pages. A user can immediately go to one of the dog-eared  
pages on the list 304 by touching a display of a selected  
page number.

30 The dog ear dialog box 302 also displays an option  
306 to display marks 308 along an edge 310 of the page.  
Thereafter, a user can touch any of the marks 308 to move  
quickly to a corresponding one of the dog-eared pages. In  
the example illustrated in FIG. 18, a mark 312 corresponds  
35 to marked page 1, a dog ear 314 corresponds to marked page  
35, a mark 316 corresponds to marked page 94, a mark 318

0 corresponds to marked page 111, and a mark 320 corresponds to marked page 120. In a preferred embodiment, page one is always marked with a dog ear so that a user can quickly return thereto using either the marks 308 or the dog ear dialog box 302.

5 Upon receiving a user-initiated event while the dog ear dialog box 302 is displayed, the dog ear dialog box 302 is removed to show the selected page of the book.

FIG. 19 is an illustration of a user selecting a portion of a page of text. A portion 330 is selected by a user-initiated event of sliding his finger 212 (or other pointing member such as a stylus) from a first position 332 to a second position 334. Upon its selection, the portion 330 of the text is highlighted in a predetermined manner. The portion 330 of the text can be highlighted in color if the touchscreen 130 is capable of a color display. Alternatively, the portion 330 of the text can be highlighted using grey scale shading, reverse video, or underlining. An option selection dialog box is then displayed on the touchscreen 130 to provide the user a number of text marking options.

FIG. 20 is an illustration of an option selection dialog box used in embodiments of the electronic book. An option selection dialog box 340 is displayed on the touchscreen 130 in a location out of the way of the portion 330 of the text that is marked when possible. The option selection dialog box 340 includes a plurality of text marking options including a note capture option 342, a highlighting option 344, a quote capture option 346, and a set bookmark option 348.

Briefly, the note capture option 342 allows a user to type in notes associated with the portion 330 of the text. The highlighting option 344 leaves the portion 330 of the text highlighted, and stores an indication of this highlighting so that any subsequent return to this page displays the portion 330 as being highlighted. The quote capture option 346 allows a user to store the portion 330

0 of the text along with source data, such as the name of  
the author of the book or the title of the book, in the  
internal machine-readable storage medium 154. The set  
bookmark option 348 can be selected to add a bookmark to  
the current page. If the page already has a bookmark,  
5 then a number of bookmark management options similar to  
options used for the dog ear command are provided to the  
user.

FIG. 21 is an illustration of an annotation display  
used in embodiments of the electronic book. The  
10 annotation display is provided in response to a user  
selecting the note capture option 342 illustrated in FIG.  
20. After receiving a user-initiated event indicative of  
selecting the note capture option 342, a soft keyboard 360  
is displayed on the touchscreen 130. The soft keyboard  
15 360 includes alphanumeric keys and symbolic keys along  
with a close key and a notes collection key.

A plurality of keystroke events are received by the  
soft keyboard 360 to form an annotation. As the keystroke  
events are received, a plurality of characters  
20 corresponding thereto are displayed in a window 362 on the  
touchscreen 130.

The user selects the close key on the soft keyboard  
360 upon completing the annotation. In response to  
selecting the close key, the electronic book removes the  
25 soft keyboard 360 and the window 362 from the touchscreen  
130 and displays a note marker icon to indicate that the  
page has an annotation associated therewith.

The notes collection key on the soft keyboard 360  
commands the electronic book to communicate the annotation  
30 to an external device such as a personal computer. The  
personal computer can be interfaced to the electronic book  
either wirelessly via the antenna 158 and the radio  
frequency modem 160 shown in FIG. 3, using a wire-based  
connection via the data interface 156, or using an  
35 infrared link.

An annotation can also be in the form of an image of

0 pixels which overlays the page of the text. The pixels  
can be drawn on the touchscreen 130 using a pointing  
device. The pixels can be stored in a pixel-map form for  
subsequent viewing or for subsequent conversion to text  
using a handwriting recognition method.

5 As another option, an accessory keyboard can be added  
to the electronic book to enter the annotation as well as  
other information.

FIG. 22 is an illustration of a marker used to  
indicate that a page has an annotation associated  
10 therewith. The page illustrated in FIG. 22 results after  
the user enters the annotation and selects the close key  
from the soft keyboard 360 as illustrated in FIG. 21. As  
shown, the page in FIG. 22 no longer has the soft keyboard  
360 and the window 362 displayed thereon. However, a note  
15 marker icon 370 is displayed in a lower corner of the  
page. The user can view the annotation associated with  
this page by selecting the note marker icon 370.  
Selecting the note marker icon 370 has the same effect as  
selecting the note capture option 342 as shown in FIG. 20.

20 Further, an annotation can be indicated by  
underlining or highlighting the portion of the text  
associated with the annotation. The annotation can be  
viewed in a hypertext-type manner by selecting the portion  
of text.

25 FIG. 23 is an illustration of a user selecting a set  
bookmark option in the option selection dialog box. The  
user selects the set bookmark option 348 by touching the  
displayed text associated therewith using his or her  
finger 212 or other pointing member. If this page had  
30 already included a bookmark, then a bookmark management  
dialog box is displayed similar to the one used for the  
dog ear command. Since the page illustrated in FIG. 23  
does not have a bookmark associated therewith, the  
selection of the set bookmark option 348 causes a bookmark  
35 to be added to the page. In a preferred embodiment, only  
one page is bookmarked within each book.

0           FIG. 24 is an illustration of the page of FIG. 23  
having a bookmark displayed thereon. A bookmark icon 380  
is displayed in an upper portion of the page to indicate  
that the page has been bookmarked.

5           It is noted that pointing devices other than an  
individual's finger may be utilized to generate user-  
initiated events indicative of desired selections using  
the touchscreen 130. For example, a stylus or the like  
can be utilized to select desired portions of the  
touchscreen 130.

10          It is also noted that various types of graphical  
controls can be utilized to control settings and  
parameters of the electronic book. These graphical  
controls include, but are not limited to, graphical  
buttons, checkboxes, radio buttons, scroll bars, slider  
15 bars, pop-up menus, and dialog boxes.

        Next, a description of steps which are performed by  
the various components of the electronic book to provide  
its features and functionality is presented. These  
operational steps are performed on or with the aid of the  
20 processor 152 illustrated in FIG. 3. The processor 152 is  
directed to function in a manner in accordance with these  
operational steps based upon a computer program or other  
form of software or firmware stored in a computer readable  
memory. The computer readable memory can be contained  
25 with the processor 152, within the internal machine-  
readable memory 154, or within a separate machine-readable  
storage medium in communication with the processor 152.

        It is noted that the order in which the steps are  
described are indicative of one embodiment of the present  
30 invention, and that alternative embodiments of the present  
invention may perform the steps in a different order to  
achieve the same functionality.

        FIG. 25 is a flow diagram of an event loop performed  
in an embodiment of the electronic book. As indicated by  
35 block 400, a step of executing a library graphical user  
interface routine is performed. The library graphical

0 user interface routine provides a virtual library to allow  
a user to select a book to read from a plurality of books  
within a library, and/or access an information service or  
world-wide web page as previously described. The  
plurality of books can be contained in one or more  
5 removable machine-readable storage media and/or the  
internal machine-readable storage medium.

Upon selecting a desired book, a step of executing a  
routine to display one or more pages of text and graphics  
from the desired book is performed as indicated by block  
10 402. The routine to display the pages of text is executed  
until a predetermined user-initiated event is received to  
exit the routine. As indicated by block 404, if a close  
book event is received, then flow of the event loop is  
directed back to the step of executing the library  
15 graphical user interface routine in block 400.

If a page back event is received when the current  
page of text being read is page one, then a step of  
displaying a title page of the book is performed as  
indicated by block 406. The title page provides a number  
20 of control options available to a user. The user selects  
a desired control option based upon a user-initiated  
event. Block 408 indicates a step of receiving this user-  
initiated event.

Based upon the user-initiated event which is  
25 received, flow of the event loop is directed to one of a  
number of subroutines in a step indicated by block 410.  
If the received event is indicative of the user selecting  
the pacing control option, then a step of executing a  
pacing control routine is performed as indicated by block  
30 412. If the received event is indicative of the user  
selecting the font selection option, then a step of  
executing a font selection routine is performed as  
indicated by block 414. If the received event is  
indicative of the user selecting the system control  
35 option, then a step of executing a system control  
subroutine is performed as indicated by block 416. If the

0 received event is indicative of the user selecting the RF  
link option, then a step of executing an RF link  
subroutine is performed as indicated by block 420. Upon  
completing either the pacing control subroutine, the font  
selection routine, the system control routine, or the RF  
5 link routine, flow of the event loop is directed back up  
to block 406 wherein the step of displaying the title page  
is performed.

If the received event from block 408 is indicative of  
the user selecting the read-to-me option, then a step of  
10 executing a read-to-me routine is performed as indicated  
by block 422. Flow of the event loop is then directed  
back to block 402 to execute the routine to display pages  
of text from the book. The execution of the read-to-me  
routine in block 422 provides a spoken, auditory display  
15 of the text in addition to the visual display of the text  
in block 402.

If the event received in the step of block 408 is an  
advance page event, then a step of setting the current  
page to page one is performed as indicated by block 424.  
20 If the received event is indicative of the user selecting  
a bookmark displayed on the title page, then a step of  
setting the current page to a previously bookmarked page  
is performed as indicated by block 426. After the current  
page is set in either of the steps indicated by blocks 424  
25 and 426, then flow of the event loop is directed back to  
the step of executing the routine to display pages of text  
indicated by block 402.

Finally, if the event received in block 408 is  
indicative of a close book event, then flow of the event  
30 loop is directed back to block 400 to perform a step of  
executing the library graphical user interface routine.

FIG. 26 is a flow diagram of steps performed in an  
embodiment of a library graphical user interface routine  
for use in the electronic book. These steps can be  
35 performed in executing the library graphical user  
interface routine indicated by block 400 in FIG. 25. The



0 steps provide a method of selecting a book for reading in  
an electronic book where the book is selected from a  
plurality of books in a library.

As indicated by block 430, a step of displaying a  
rearward graphical book representation having a graphical  
5 spine portion is performed. A step of displaying a  
forward graphical book representation in front of the  
rearward graphical book representation is performed as  
indicated by block 432. The forward graphical book  
representation has a graphical spine portion and a  
10 graphical front cover portion.

As indicated by block 434, a step of displaying a  
title of a first book of the plurality of books on the  
forward graphical book representation is performed. The  
title of the first book can be displayed anywhere on the  
15 forward graphical book representation. However, in a  
preferred embodiment, the title of the first book is  
displayed on the graphical spine portion of the forward  
graphical book representation. FIG. 5 illustrates an  
example of the rearward graphical book representation 200  
20 having the graphical spine portion 202, the forward  
graphical book representation 204 having the graphical  
spine portion 206 and the graphical front cover portion  
208, and the title 210 displayed on the forward graphical  
book representation 204.

25 With reference again to FIG. 26, a step of receiving  
a first user-initiated event in which a portion of the  
rearward graphical book representation is selected is  
performed as indicated by block 436. In a preferred  
embodiment, the portion of the rearward graphical book  
30 representation selected in this step is within the  
graphical spine portion of the rearward graphical book  
representation. Upon receiving the first user-initiated  
event, a step of displaying a title of a second book of  
the plurality of books is performed as indicated by block  
35 440. Preferably, the title of the second book is  
displayed in place of the title of the first book on the

0 graphical spine portion of the forward graphical book representation.

As indicated by block 442, a step is performed of receiving a second user-initiated event in which a portion of the forward graphical book representation is selected.

5 In a preferred embodiment, the portion of the forward graphical book representation selected in this step is within the front cover portion of the forward graphical book representation. The reception of the second user-initiated event ends the execution of the library  
10 graphical user interface routine, and flow is directed to the routine to display pages of text from the second book. Here, steps are performed of reading machine-readable data from a machine-readable storage medium installed in the electronic book, the machine-readable data being  
15 representative of text from the second book, and displaying the text represented by the machine-readable data.

It is noted that the steps indicated by blocks 436 and 440 can be repeated to allow the user to rotate  
20 through the plurality of books. When the first user-initiated event is received while a last of the plurality of books is displayed, the next title displayed is that of the first of the plurality of books.

It is preferred that steps of displaying and  
25 receiving user-initiated events all be performed using the touchscreen 130 integrated in the electronic book. However, in alternative embodiments of the electronic book which include a series of buttons external to the touchscreen 130, any of the above-described user-initiated  
30 events may be received using these buttons.

FIGS. 27 and 28 show flow diagrams of an embodiment of the routine to display pages of text in the electronic book. The steps indicated in these flow diagrams are performed in one embodiment of the step indicated by block  
35 402 in FIG. 25.

0           Upon entering the routine, a step of displaying a  
current page of the book is performed as indicated by  
block 450. The current page includes text from the  
current page of the book, a graphical display of a number  
of pages remaining in the book, a display of a bookmark  
5 graphic if there is a bookmark associated with the current  
page, a dog ear graphic if the current page is dog-eared,  
and a note marker icon if there is an annotation  
associated with the current page. Optionally, the current  
page includes graphics from the current page of the book.  
10           After displaying the current page, a branching step  
is performed, as indicated by block 452, based upon any  
user-initiated events which are received. If a user-  
initiated event is received which selects a portion of the  
text, a step of marking the portion of the text is  
15 performed as indicated by block 454. The portion of the  
text can be marked either by color or grey scale  
highlighting the portion of the text, underlining the  
portion of the text, or displaying the portion of the text  
in a reverse video form. The portion of the text can be  
20 selected directly by a user sliding a finger or a stylus  
over the portion of the text. Alternatively, the portion  
of the text can be selected indirectly by a menu selection  
technique.  
          After the portion of the text has been marked, a step  
25 of displaying an option selection dialog box is performed  
as indicated by block 456. The option selection dialog  
box provides a plurality of options to the user, including  
a note capture option, a highlighting option, a quote  
capture option, and a set bookmark option.  
30           As indicated by block 460, a step of receiving a  
user-initiated event indicative of a selection of one of  
the options is performed. Based upon the selection, a  
branching step is performed as indicated by block 462. If  
the note capture option is selected, then a step of  
35 executing an annotation subroutine is performed as  
indicated by block 454. If the quote capture option is

0 selected, then a step of executing a quote capture  
subroutine is performed as indicated by block 466. If the  
highlighting option is selected, then a step of executing  
a highlighting subroutine is performed as indicated by  
block 470. If the set bookmark option is selected, then a  
5 step of executing a bookmark subroutine is performed as  
indicated by block 472.

Upon completing the execution of either the  
annotation subroutine, the quote capture subroutine, the  
highlighting subroutine, or the bookmark subroutine, a  
10 step of determining whether a pacing mode is active is  
performed as indicated by block 474. If the pacing mode  
is inactive, then flow of the routine is directed back to  
block 452 which performs a branching step based upon a  
received user-initiated event. If the pacing mode is  
15 active, then a step of determining whether a highlighting  
mode is active is performed as indicated by block 476. If  
the highlighting mode is active then a step of scrolling a  
highlight across the current page is performed as  
indicated by block 480. Scrolling the highlight across  
20 the current page allows pacing of a user's scanning across  
the current page. A user can activate the highlighting  
mode to help enhance his or her reading speed.

The highlight which is scrolled across the page can  
be in the form of either a color or grey scale highlight,  
25 an underlining of text, or a reverse video form of text.  
If the touchscreen 130 is capable of selective  
backlighting, then the highlight can be in the form of a  
selective backlighting of a reduced portion of the  
touchscreen 130.

30 After scrolling the highlight across the current page  
in block 480 or if the highlighting mode is inactive, then  
a step of determining whether it is time for displaying a  
subsequent page is performed as indicated by block 482.  
If the time has not yet come for displaying a subsequent  
35 page, then flow is directed back to block 452. If the  
time has arrived for displaying a subsequent page, then a

0 step of updating the current page is performed as  
indicated by block 484. Next, a step of displaying a  
forward page turn in an animated matter is performed as  
indicated by block 486. This step includes displaying an  
5 animated sequence of images which simulates a forward  
flipping of a page. Flow of the routine is then directed  
back to block 450 to display the new current page.

With reference to block 452, if a user-initiated  
event is received indicative of the user selecting the  
note marker icon, then the step of executing the  
10 annotation routine indicated by block 464 is performed.  
Thereafter, subsequent steps are performed beginning with  
the step indicated by block 474.

With reference to the branching step performed in  
block 452, if a dog ear user-initiated event is received,  
15 then a step of executing a dog ear routine is performed as  
indicated by block 490. If the user-initiated event is  
indicative of the user selecting the bookmark portion of  
the page, then a step of executing a bookmark management  
routine is performed as indicated by block 491.  
20 Thereafter, subsequent steps are performed beginning with  
the step indicated by block 474. Similarly, if no user-  
initiated events are received in block 452, then flow of  
the routine is directed to the step indicated by block  
474.

25 If the user-initiated event is indicative of the user  
selecting the page back portion of the page, then flow  
from block 452 branches to a step of decrementing the  
current page as indicated by block 492. Further, a step  
of displaying a backward page turn in an animated matter  
30 is performed as indicated by block 494. This step  
includes displaying an animated sequence of images which  
simulates a backward flipping of a page. The steps  
indicated by blocks 486 and 494 give the user the sense or  
feel that a page of information is being turned in place,  
35 carrying forward the familiar paradigm of turning the page  
on a standard paper book.

0           As indicated by block 496, a step of determining  
whether the new current page is the title page is  
performed after the step of block 494. If the new current  
page is the title page, then execution of the routine to  
display pages of text in the electronic book is completed  
5           as indicated by block 500. If the new current page is any  
page but the title page, then flow of the routine is  
directed back to block 450 wherein a step of displaying  
the new current page is performed.

          If the user-initiated event is indicative of the user  
10          selecting the advance page portion of the page, then flow  
is directed from the step indicated by block 452 to a step  
of incrementing the current page as indicated by block  
502. Further, a step of displaying a forward page turn in  
an animated matter is performed as indicated by block 504.  
15          Flow of the routine is then directed back to block 450  
wherein the new, incremented current page is displayed.

          FIG. 29 is a flow diagram of steps performed to  
display a current page in the electronic book. These  
steps constitute one embodiment of a method of performing  
20          the step indicated by block 450 in FIG. 27.

          As indicated by block 510, a step of displaying text  
from the current page of the book is performed. The text  
is displayed in accordance with a primary font parameter  
and a primary size parameter. If there is any  
25          highlighting associated with a portion of the text on the  
current page, then a step of displaying the portion of the  
text in a highlighted manner is performed as indicated by  
block 512. If any graphical information is included in  
the current page, then a step of displaying the graphical  
30          information is performed as indicated by block 513.

          As indicated by block 514, a step of graphically  
displaying a number of pages remaining in the book is  
performed. The number of pages remaining in the book can  
be displayed in the sixth portion 188 of the touchscreen  
35          130 as illustrated in FIG. 4. The number of pages  
remaining in the book can be graphically displayed using

0 either an image of a number of pages, a dark line as a  
drop shadow, or a group of parallel lines to indicate  
relative depth by page number in a given document. When  
the current page is one of the early pages in the book,  
the drop shadow or graphical image depth is relatively  
5 deep, indicating that there is a significant portion of  
the book remaining to be read. When the current page is  
near the middle of the book, the drop shadow or graphical  
image depth is half as deep. When nearing the end of the  
book, the drop shadow or graphical image depth becomes  
10 very thin indicating that the reader is almost at the end  
of the book. As a result, the user can determine at a  
glance how much of the book has been read, and their  
relative position within the book just as a standard paper  
book. As an alternative to using a top portion of the  
15 touchscreen for graphically displaying the number of pages  
remaining in the book, a side edge and/or a bottom edge of  
the touchscreen 130 can be utilized to provide this  
graphical display.

As indicated by block 516, a step of determining if a  
20 bookmark is associated with the current page is performed.  
If a bookmark is associated with the current page, then a  
step of displaying a bookmark graphic is performed as  
indicated by block 520.

As indicated by block 522, a step of determining if  
25 the current page is dog-eared is performed. If the  
current page is dog-eared, then a step of displaying a dog  
ear graphic is performed as indicated by block 524.

As indicated by block 526, a step of determining  
whether an annotation exists for the current page is  
30 performed. If there is an annotation associated with the  
current page, then a step of displaying a note marker icon  
is performed as indicated by block 530.

FIG. 30 is a flow diagram of steps performed in an  
embodiment of an annotation routine. Such an annotation  
35 routine is executed in the step indicated by block 464 in  
FIG. 28.

0           As indicated by block 540, a step of displaying a  
window for displaying the annotation is performed. As  
indicated by block 542, a step of displaying a soft  
keyboard on the touchscreen 130 is performed. The soft  
keyboard is provided to receive a plurality of keystroke  
5 events to form the annotation.

          After displaying the soft keyboard and the annotation  
window, a step of receiving a keystroke event is performed  
as indicated by block 544. As indicated by block 546, a  
branching operation is performed based upon the keystroke  
10 event received in block 544. If the keystroke event is  
indicative of the user selecting either an alphanumeric  
key or a symbolic key on the soft keyboard, then a step of  
displaying a character associated with the key is  
performed as indicated by block 560. The character  
15 associated with the key is displayed within the annotation  
window. After displaying the character, flow of the  
routine is directed back to block 544 wherein a subsequent  
keystroke event is received.

          Referring back to the branching step indicated by  
20 block 546, if the keystroke event is indicative of a user  
selecting the close key from the soft keyboard, then a  
step of closing the soft keyboard is performed as  
indicated by block 562. A step of closing the annotation  
window is also performed, as indicated by block 564. As  
25 indicated by block 566, a step of displaying a note marker  
icon on the page is performed. Thereafter, execution of  
the annotation subroutine is completed.

          With reference again to the branching step performed  
in block 546, if the keystroke event is indicative of the  
30 user selecting the notes collection key, then a step of  
communicating the annotation to an external personal  
computer is performed as indicated by block 570. After  
communicating the annotation to the personal computer,  
flow of the routine is directed back to block 544 wherein  
35 a subsequent keystroke event is received.

          FIG. 31 is a flow diagram of steps performed in an



0 embodiment of a quote capture subroutine. Such a quote  
capture subroutine can be performed to provide the step  
indicated by block 466 in FIG. 28.

Prior to entering the quote capture subroutine, a  
user-initiated event was received in the electronic book  
5 which selects a portion of the text displayed on the  
touchscreen. After receiving the user-initiated event, a  
plurality of text marking options, including a quote  
capture option, is displayed, and a user-initiated event  
indicative of a user selecting the quote capture option is  
10 received.

As indicated by block 580, a step of storing quote  
data representative of the portion of the text is  
performed. The quote data is stored in the internal  
machine-readable storage medium 154 illustrated in FIG. 3.

15 As indicated by block 582, a step of storing source  
data which identifies the source of the quote data is  
performed. The source data can be representative of the  
author of the book, the title of the book, a copyright  
date of the book, and/or a publisher of the book. The  
20 source data is stored in the internal machine-readable  
storage medium 154 from FIG. 3.

As indicated by block 584, a step is performed of  
maintaining the quote data and the source data in the  
internal machine-readable storage medium when the  
25 removable machine-readable storage medium is removed from  
the electronic book. As a result of this step, subsequent  
steps can be performed based upon the quote data and the  
source data when the removable machine-readable storage  
medium is removed. Specifically, a step of retrieving the  
30 quote data and the source data from the internal machine-  
readable storage medium can be performed when the  
removable machine-readable storage medium is removed from  
the electronic book. Thereafter, a step of displaying the  
portion of the text represented by the quote data and  
35 source information represented by the source data can be  
performed.

0           FIG. 32 is a flow diagram of steps performed in an embodiment of a dog ear subroutine. Such a dog ear subroutine is executed in the step indicated by block 490 in FIG. 27.

5           As indicated by block 590, a step is performed of determining a duration in which a dog ear portion of the touchscreen is held. A step of comparing the duration to a predetermined threshold is performed as indicated by block 592. The predetermined threshold can be about a second. If the duration is less than the predetermined threshold,  
10 then a step of determining whether the current page has a dog ear is performed as indicated by block 594. If the current page does not have a dog ear, then a step of storing an indication that the current page be dog-eared is performed as indicated by block 596. Further, a step  
15 of displaying a dog ear graphic in an upper corner portion of the touchscreen 130 is performed as indicated by block 600. Thereafter, execution of the dog ear subroutine is completed.

20           With reference to blocks 592 and 594, if the duration is greater than or equal to the predetermined threshold or if the current page is already dog-eared, then a step of displaying a dog-eared dialog box is performed as indicated by block 602. Within the dog-eared dialog box, a list of all marked pages is displayed. Further, an  
25 option to show marks corresponding to all of the marked pages along an edge of each page is displayed.

          As indicated by block 604, a user-initiated event is received. As indicated by block 606, a branching step is performed based upon the user-initiated event received.  
30 If the user-initiated event is indicative of a user selecting a page number from the list of marked pages, then a step of setting the current page to the selected page number is performed as indicated by block 610. If the user-initiated event is indicative of the user  
35 selecting the marking option, then a step of displaying marks corresponding to the dog-eared pages along an edge

0 of the page is performed as indicated by block 612.

FIG. 33 is a flow diagram of steps performed in an embodiment of a pacing control subroutine. The pacing control subroutine is executed in the step indicated by block 472 in FIG. 25.

5 As indicated by block 620, a step of determining a number of pages remaining in the book is performed. As indicated by block 622, a step of determining a current reading pace of the user is performed.

Based upon the number of pages remaining in the book,  
10 a step of calculating one or more estimated completion times is performed as indicated by block 624. A first estimated completion time can be calculated by dividing the number of words or pages remaining in the book by the current reading pace of the user. As a result, the first  
15 estimated completion time estimates how long it would take the user to complete the book at his or her current reading pace. A second estimated completion time is calculated by dividing the number of words or pages remaining in the book by a desired reading pace. The  
20 second estimated completion time estimates how long it would take the user to complete the book at the desired reading pace.

As indicated by block 626, a step of displaying each estimated completion time is performed. Each estimated  
25 completion time can be displayed within a corresponding sentence as illustrated in FIG. 15.

As indicated by block 630, a step of calculating a necessary reading pace to satisfy a predetermined reading goal is performed. The predetermined reading goal can be  
30 in the form of a time duration within which a user wishes to complete the pages remaining in the book. Here, the necessary reading pace is calculated by dividing the number of pages remaining in the book by the time duration. A step of displaying the necessary reading pace  
35 to satisfy the reading goal is then performed as indicated by block 632.

0 As indicated by block 634, a step of displaying one  
or more graphical pacing controls is performed. As  
illustrated in FIG. 15, the one or more graphical pacing  
controls can include a graphical slider bar such as the  
graphical slider bar 294 used for modifying the desired  
5 reading pace, and a graphical switch such as the graphical  
switch 296 which is used for enabling and disabling an  
automatic pacing of the text using a pacing routine.

As indicated by block 636, a user-initiated event is  
received. As indicated by block 640, if the user-  
10 initiated event is indicative of the user selecting the  
page back portion of the touchscreen 130, then execution  
of the pacing control subroutine is terminated. Upon  
terminating the pacing control subroutine, the system  
control page is displayed on the touchscreen 130.

15 If the user-initiated event is not indicative of the  
user selecting the page back portion, then a step of  
updating a pacing parameter based on the user-initiated  
event is performed as indicated by block 642. Examples of  
the pacing parameter include the desired reading pace and  
20 the reading goal. After updating the pacing parameter,  
flow of the subroutine is directed back to block 624 to  
recalculate an estimated completion time and the necessary  
reading pace.

FIG. 34 is a flow diagram of steps performed in an  
25 embodiment of the font selection subroutine. The font  
selection subroutine is executed in block 414 in the event  
loop of FIG. 25.

As indicated by block 650, a step of displaying a  
plurality of words using a corresponding plurality of  
30 combinations of different fonts and different sizes is  
performed. More specifically, each word is displayed  
using a specific font and a specific size in accordance  
with the combination corresponding thereto. Optionally,  
the step of displaying the plurality of words can include  
35 displaying a respective font name for each of the  
combinations. As another option, the step of displaying

0 the plurality of words can include displaying a single  
textual expression using the corresponding plurality of  
combinations.

As indicated by block 652, a step of receiving a  
user-initiated event indicative of the user selecting one  
5 word of the plurality of words is performed. This  
selection indicates which font/size combination is desired  
by the user.

As indicated by block 654, a step of updating a  
primary font parameter and a primary size parameter is  
10 performed. The primary font parameter and the primary  
size parameter are updated in accordance with the  
font/size combination selected by the user. As indicated  
by block 656, a step of automatically returning to  
displaying the title page is performed after receiving the  
15 user-initiated event selecting the one word. Thereafter,  
a subsequent step of displaying text of a book includes  
displaying the text using the primary font in a size at  
least the primary size.

FIG. 35 is a flow diagram of steps performed in an  
20 embodiment of the system control subroutine. The system  
control subroutine is executed in the step indicated by  
block 416 in the event loop of FIG. 25.

As indicated by block 660, a step of displaying a  
plurality of graphical controls for setting system  
25 parameters is performed. The system parameters can  
include display parameters such as a contrast parameter, a  
tint parameter, and a color parameter. The system  
parameters can also include a sound parameter.

As indicated by block 662, a step of receiving a  
30 user-initiated event is performed. If the user-initiated  
event is indicative of the user selecting the page back  
portion of the touchscreen, as indicated by block 664,  
then execution of the system control subroutine is  
completed. For other user-initiated events, a step of  
35 updating a system parameter is performed as indicated by  
block 668.

0           Thus, there has been described herein a concept, as well as several embodiments including preferred embodiments of an electronic book and a method of selecting a primary font and a primary size for displaying text therewith.

5           Because the various embodiments of the present invention allow a user to select a desired font/size combination for displaying textual information by viewing a plurality of words displayed in a plurality of font/size combinations and directly selecting the desired font/size  
10 combination therefrom, they provide a significant improvement in that the user can simultaneously select the font and the size using a single user-initiated event. Further, the user can view how words appear in all of the font/size combinations to aid in selecting the desired  
15 font/size combination.

          Additionally, the various embodiments of the present invention automatically return to a predetermined page in the book after receiving the font/size selection in order to reduce the number of user-initiated actions required  
20 for the selection.

          It will be apparent to those skilled in the art that the disclosed invention may be modified in numerous ways and may assume many embodiments other than the preferred form specifically set out and described above.

25           Accordingly, it is intended by the appended claims to cover all modifications of the invention which fall within the true spirit and scope of the invention.

          What is claimed is:

## 0 Claims

1. A method of selecting a primary font and a primary size for displaying text in an electronic book having a book-shaped housing, the primary font selected  
5 from a plurality of fonts, the primary size selected from a plurality of sizes, the method comprising the steps of:  
displaying a plurality of words using a corresponding plurality of combinations of the plurality of fonts and the plurality of sizes;  
10 receiving a user-initiated event in which one word of the plurality of words is selected;  
updating the primary font to a font with which the one word is displayed; and  
updating the primary size to a size in which the one  
15 word is displayed.
2. The method of claim 1 further comprising the steps of:  
prior to displaying the plurality of words,  
20 displaying a page of a book including a plurality of control options, the plurality of control options including a font selection option; and  
receiving a second user-initiated event in which the font selection option is selected;  
25 wherein the step of displaying the plurality of words is performed in response to receiving the second user-initiated event.
3. The method of claim 1 further comprising the  
30 step of displaying text of a book represented by machine-readable data contained in a machine-readable storage medium after updating the primary size, wherein the text is displayed in a size at least the primary size.

0

4. The method of claim 1 wherein the step of displaying the plurality of words includes displaying a single textual expression using the corresponding plurality of combinations.

5

5. The method of claim 1 wherein the step of displaying the plurality of words includes displaying a respective font name for each of the plurality of combinations.

10

6. An electronic book comprising:

a book-shaped housing having a first housing member pivotably connected to a second housing member to open and close in a book-like manner;

15

a processor housed by the book-shaped housing, the processor operative to read machine-readable data from a machine-readable storage medium installed in the electronic book, the machine-readable data representative of text from a book; and

20

a touchscreen integrated in the book-shaped housing to be accessible when the book-shaped housing is opened in the book-like manner, the touchscreen in communication with the processor to select a primary font and a primary size for displaying the text from the book, wherein the primary font is selected from a plurality of fonts and the primary size is selected from a plurality of sizes, the touchscreen operative to display a plurality of words using a corresponding plurality of combinations of the plurality of fonts and the plurality of sizes and to receive a user-initiated event in which one word of the plurality of words is selected;

25

30

wherein the primary font is updated to a font with which the one word is displayed, and wherein the primary size is updated to a size in which the one word is displayed.

35



0

7. The electronic book of claim 6 wherein prior to displaying the plurality of words, the touchscreen displays a page of a book having a plurality of control options which include a font selection option and receives a second user-initiated event in which the font selection option is selected, and wherein the touchscreen displays the plurality of words in response to receiving the second user-initiated event.

5

10

8. The electronic book of claim 6 wherein the touchscreen displays the text from the book after updating the primary size, wherein the text is displayed in a size at least the primary size.

15

9. The electronic book of claim 6 wherein the touchscreen displays the plurality of words by displaying a single textual expression using the corresponding plurality of combinations.

20

10. The electronic book of claim 6 wherein the touchscreen displays the plurality of words by displaying a respective font name for each of the plurality of combinations.

25

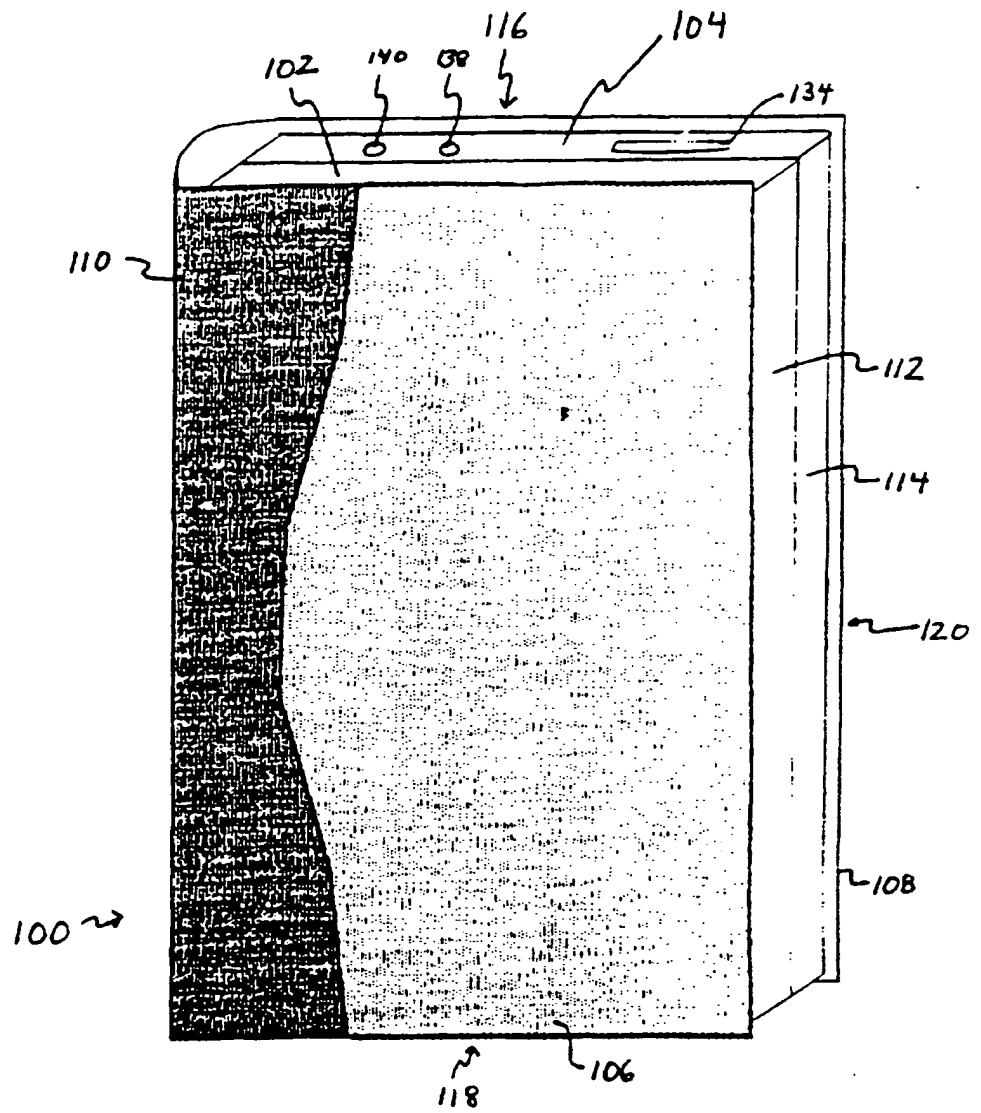

FIG. 1

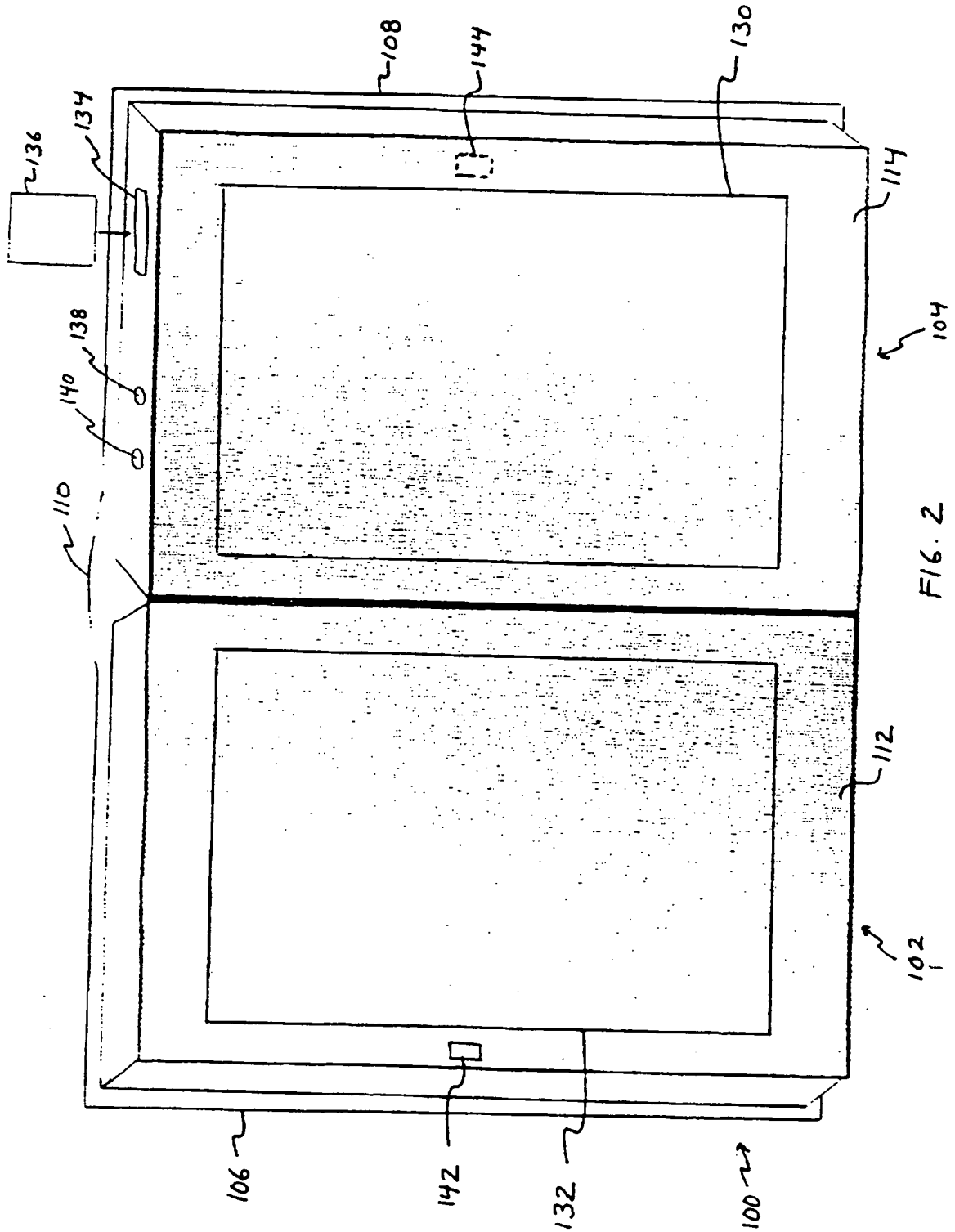

FIG. 2

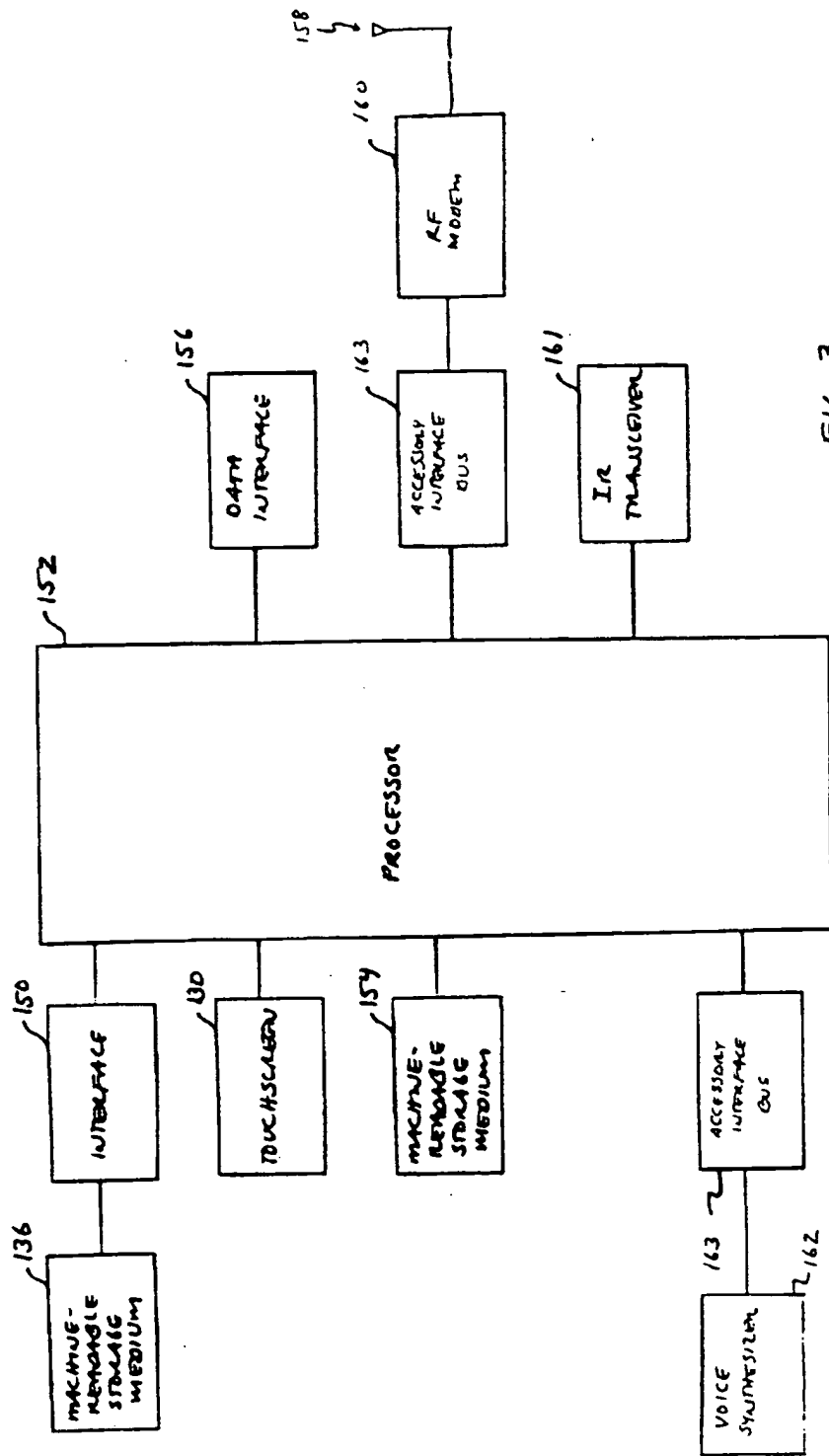

FIG. 3

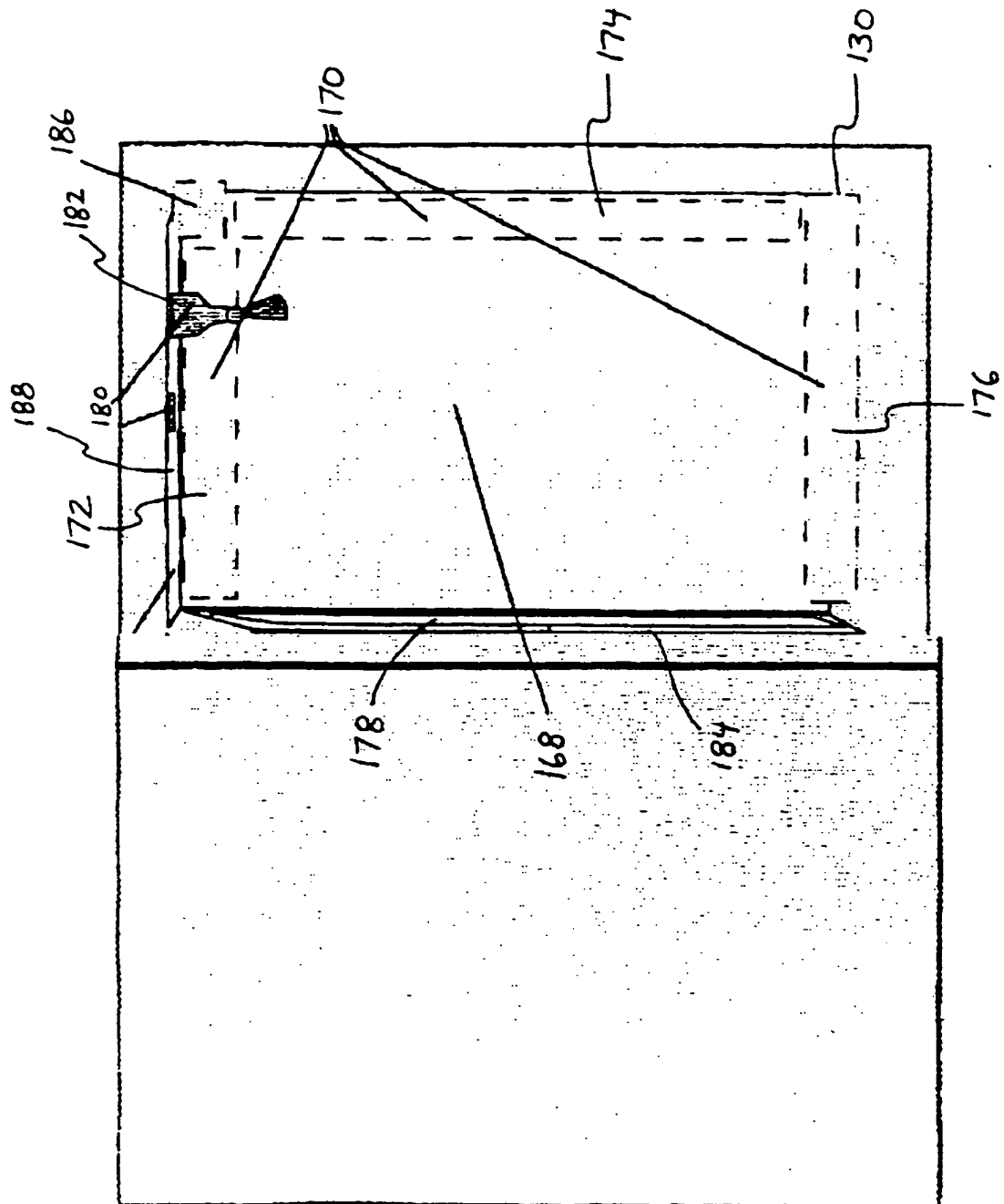

FIG. 4

4/35

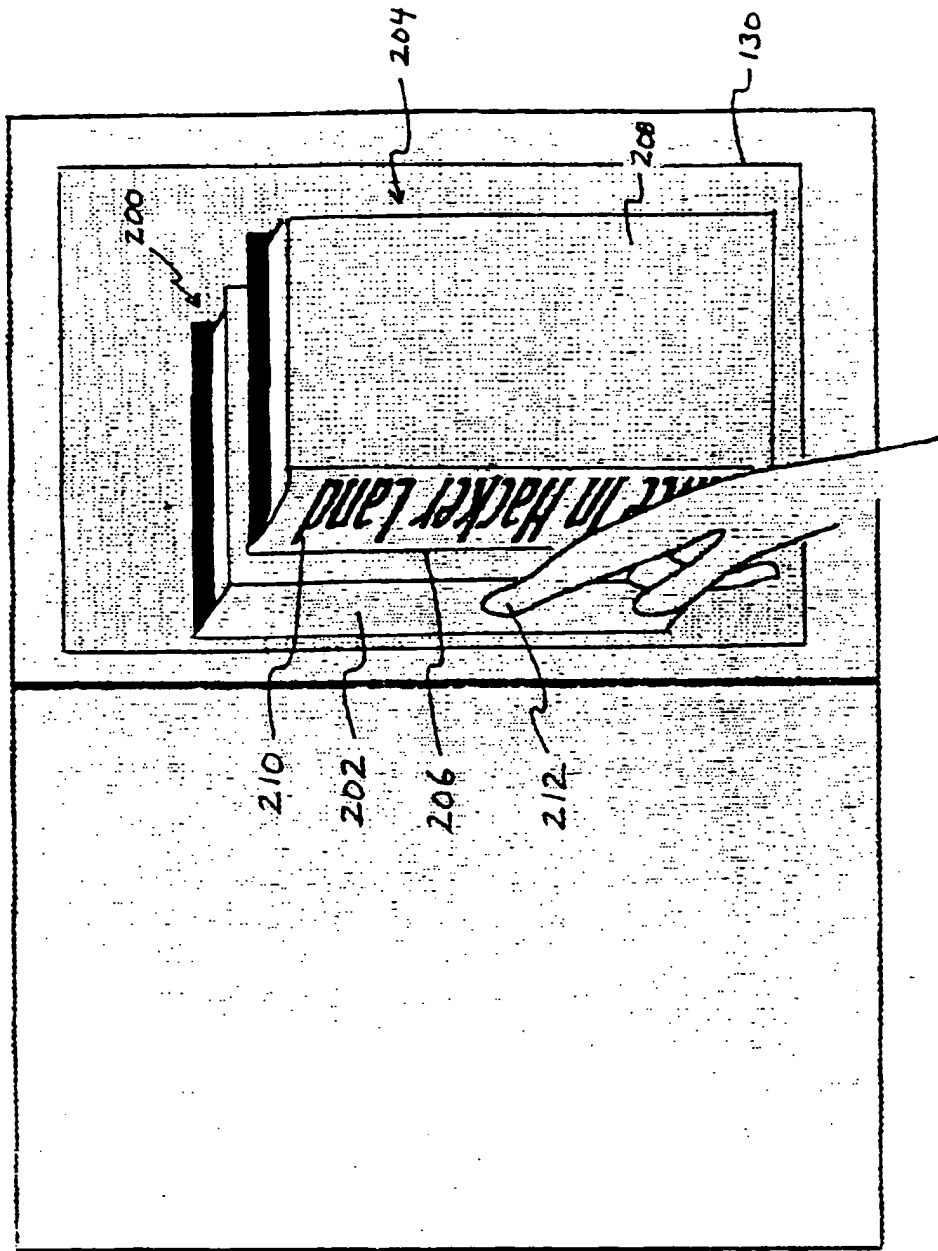

FIG. 5.

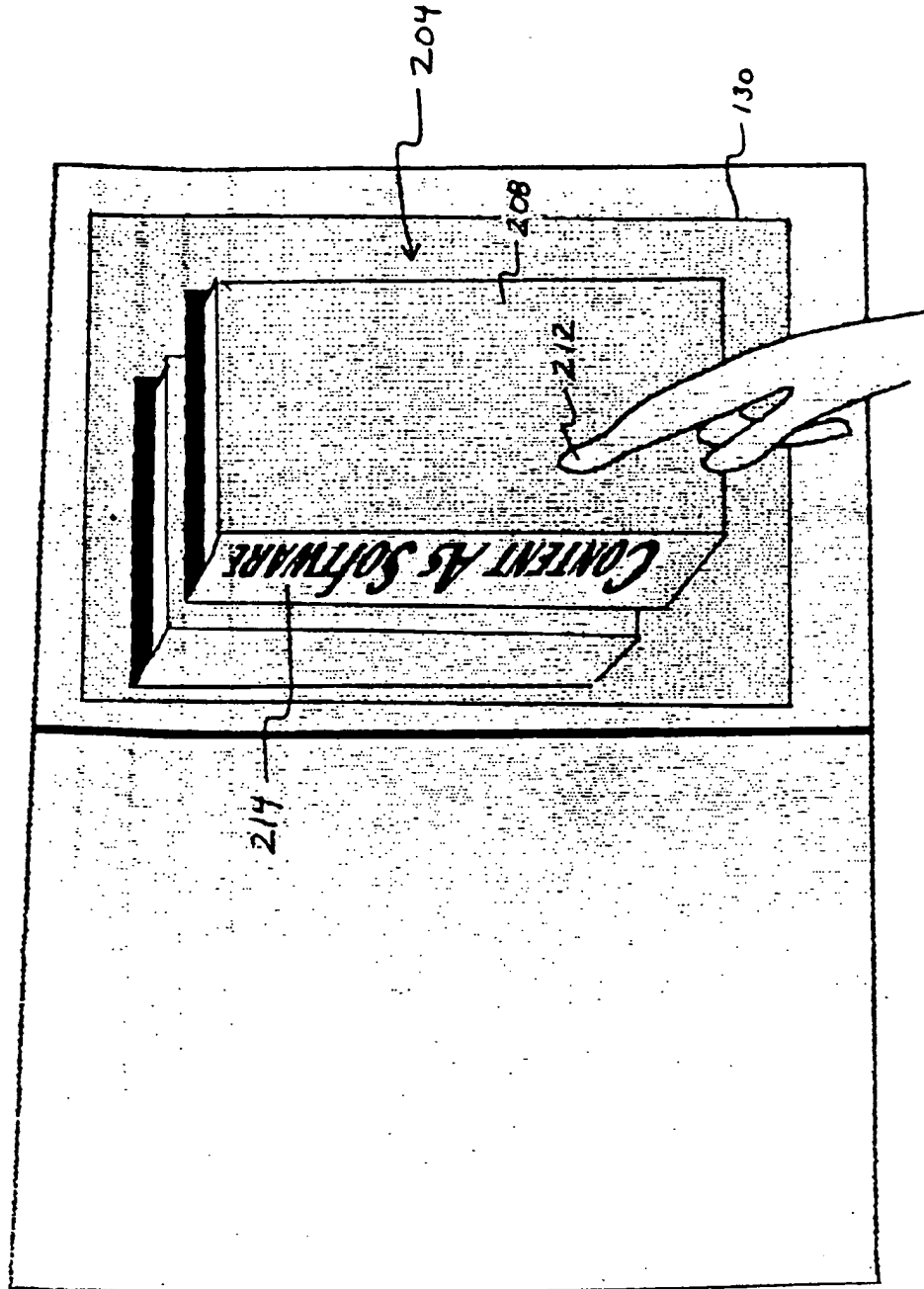

FIG. 6

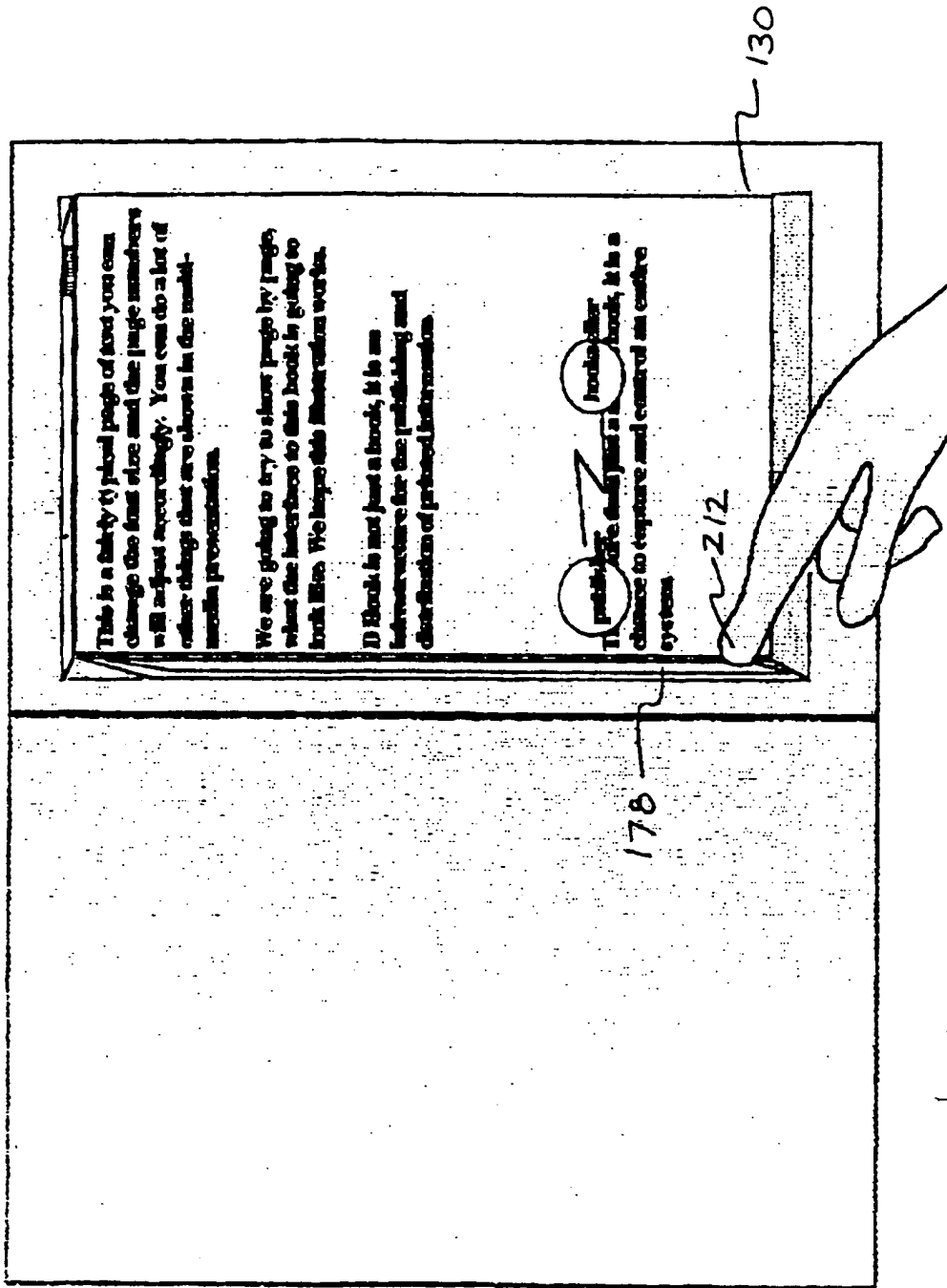

FIG. 7



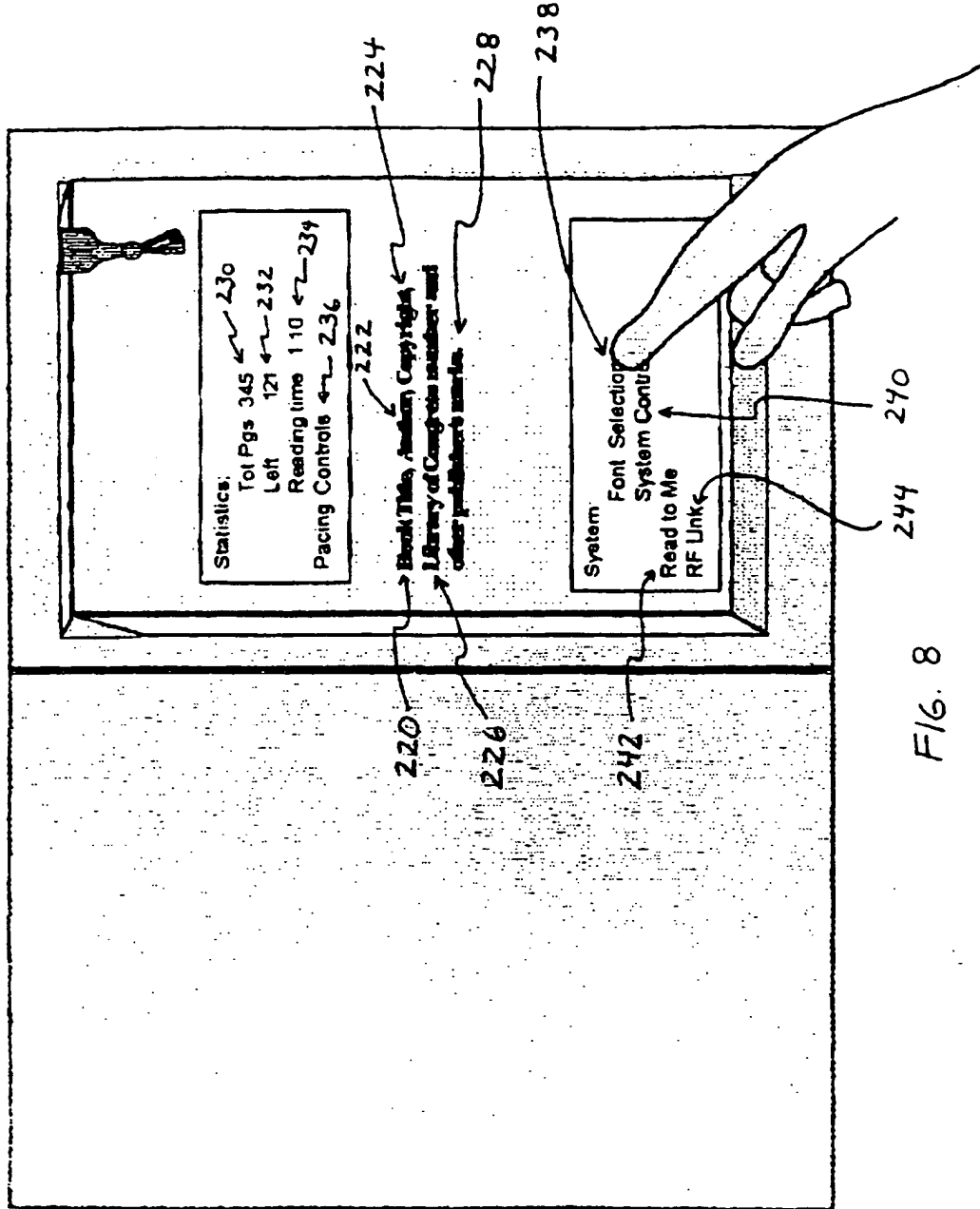

FIG. 8

8/35

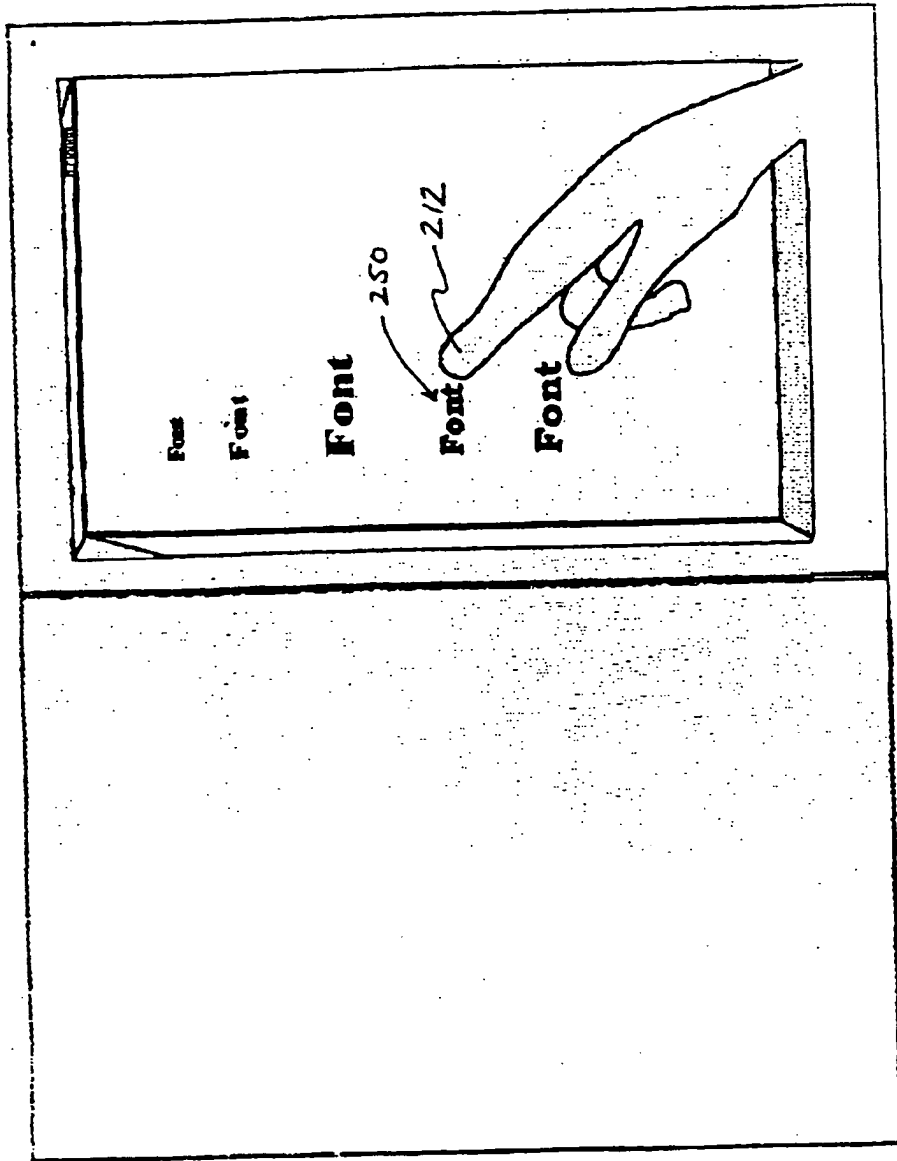

FIG. 9

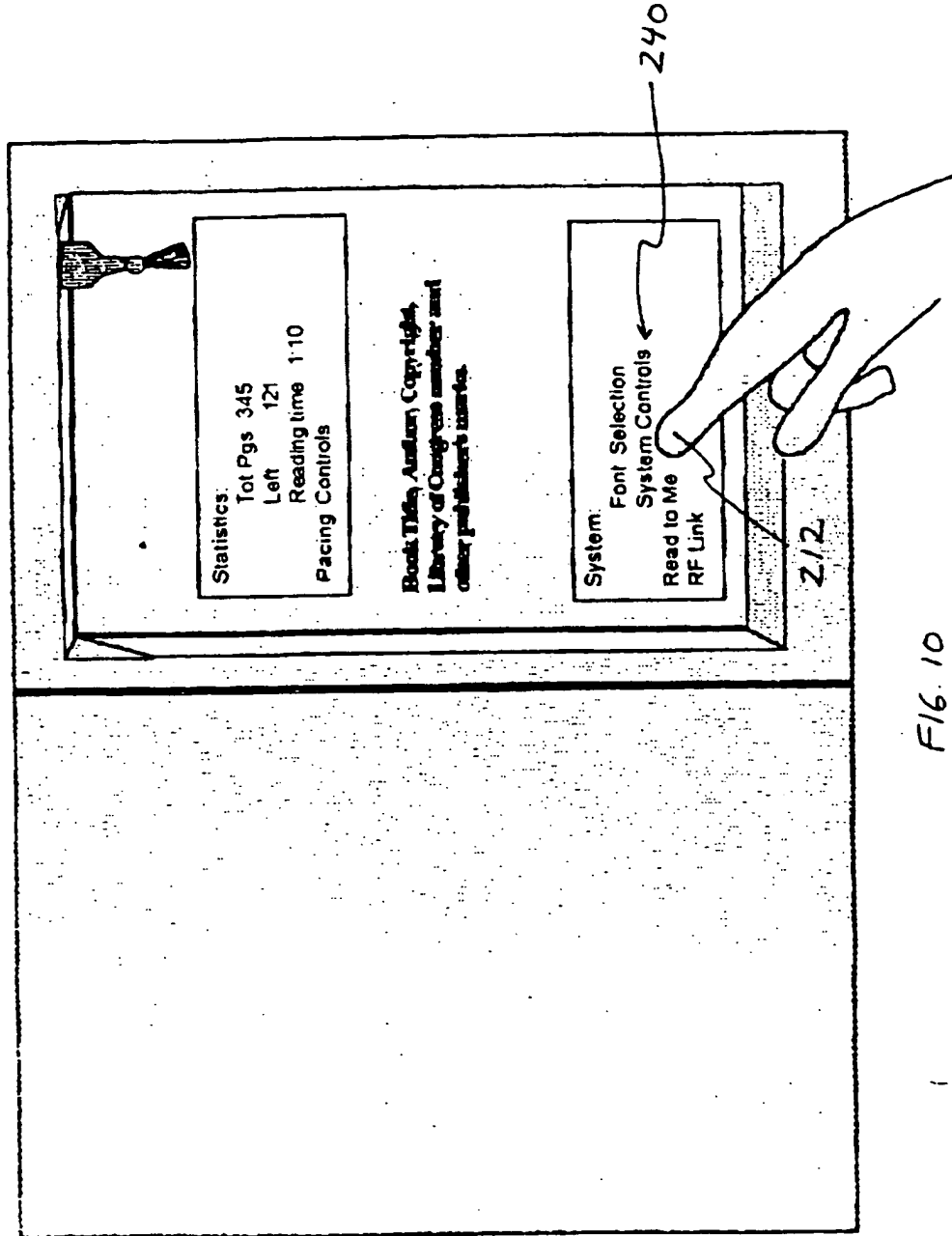

FIG. 10

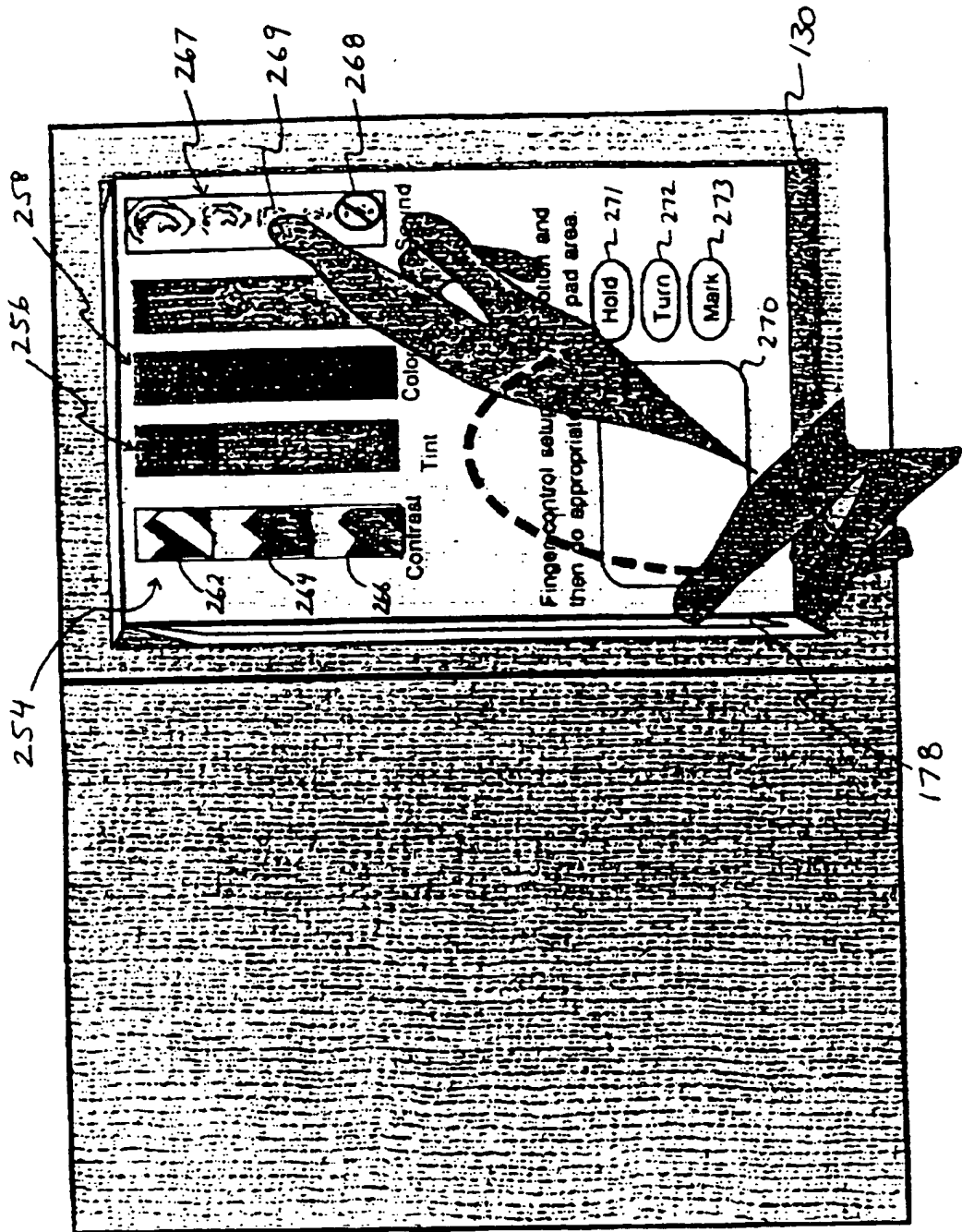

FIG. 11

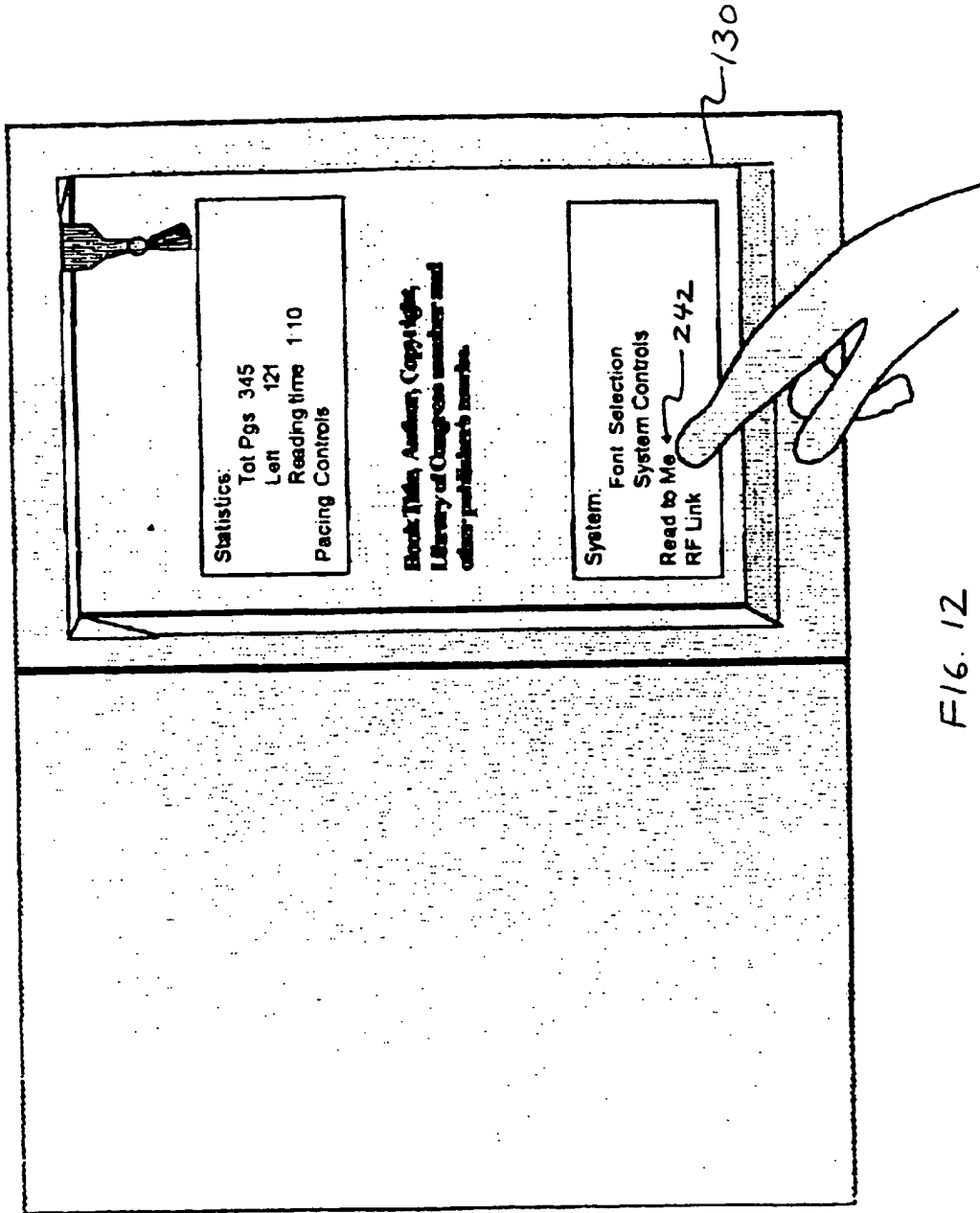
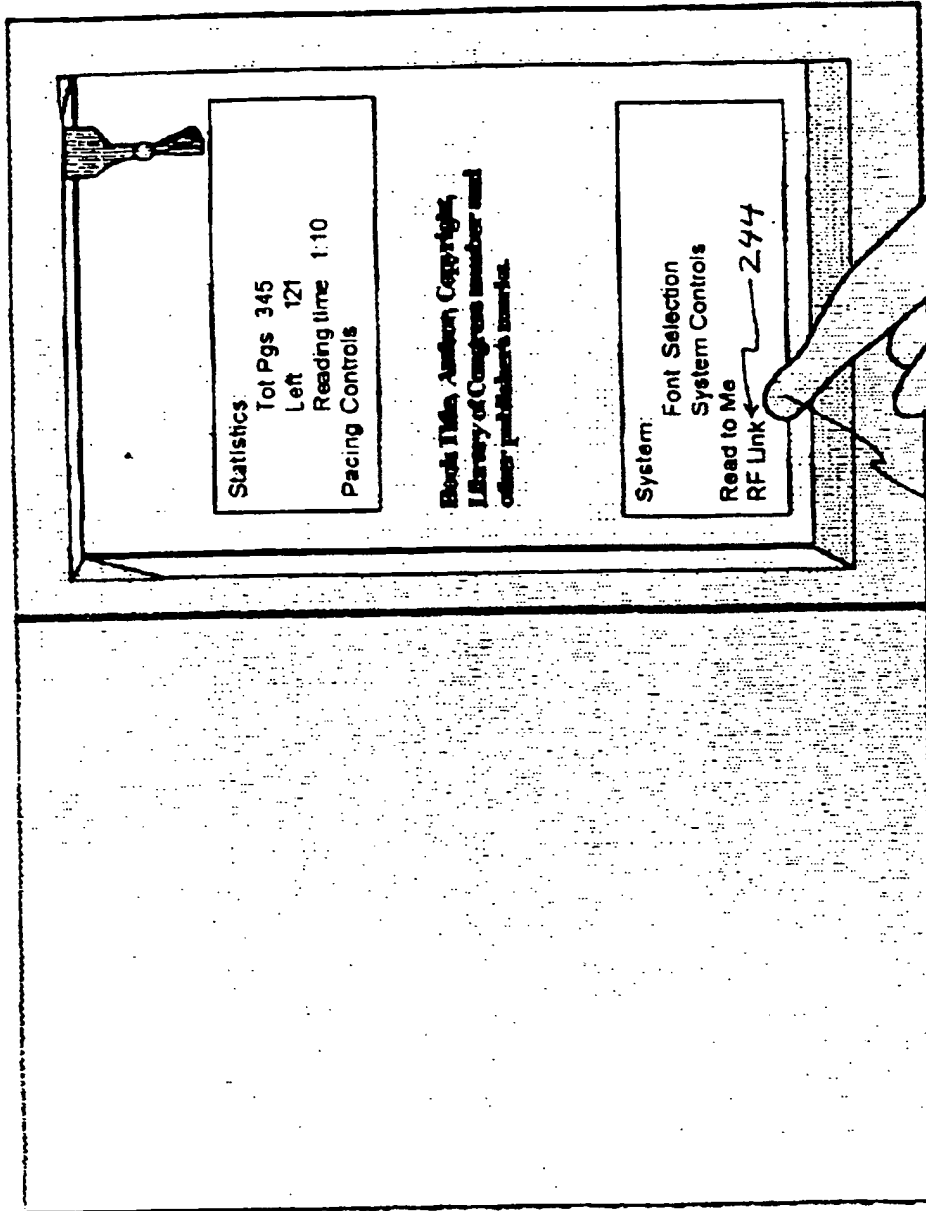

FIG. 12



212

FIG. 13

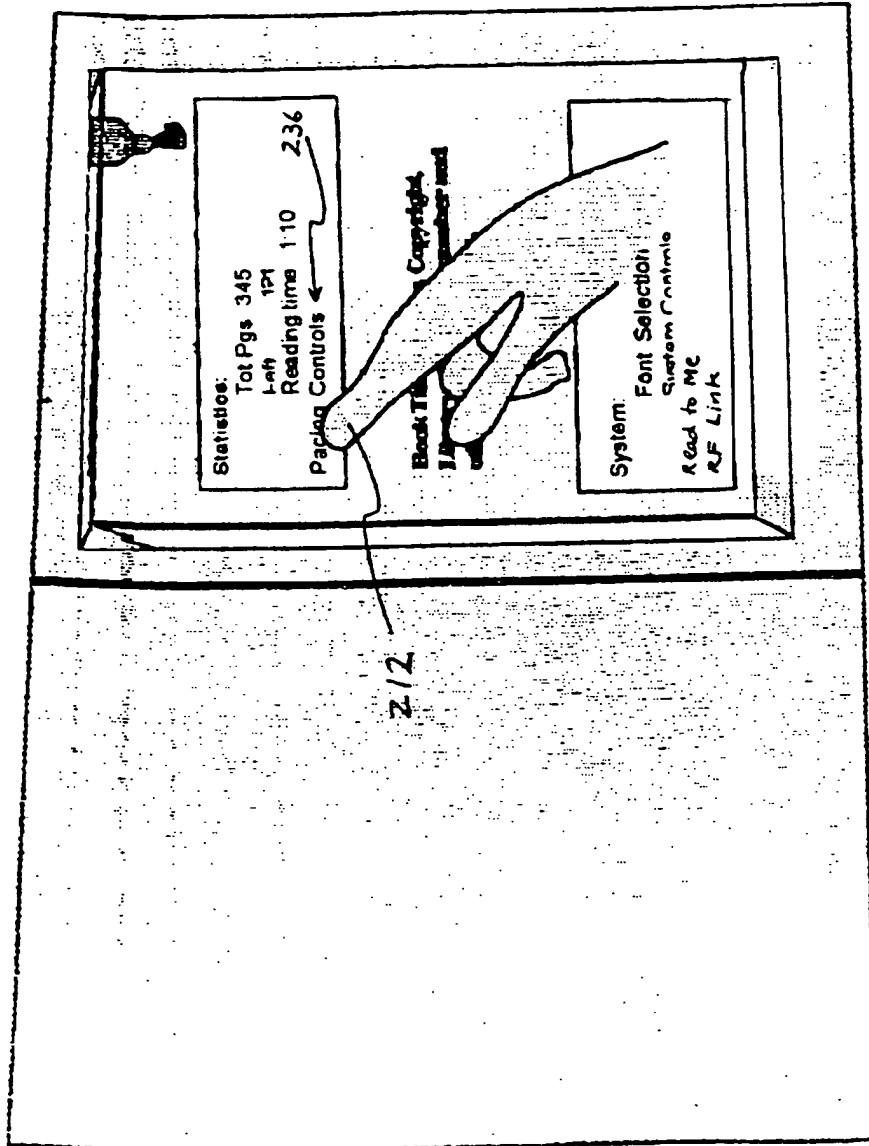
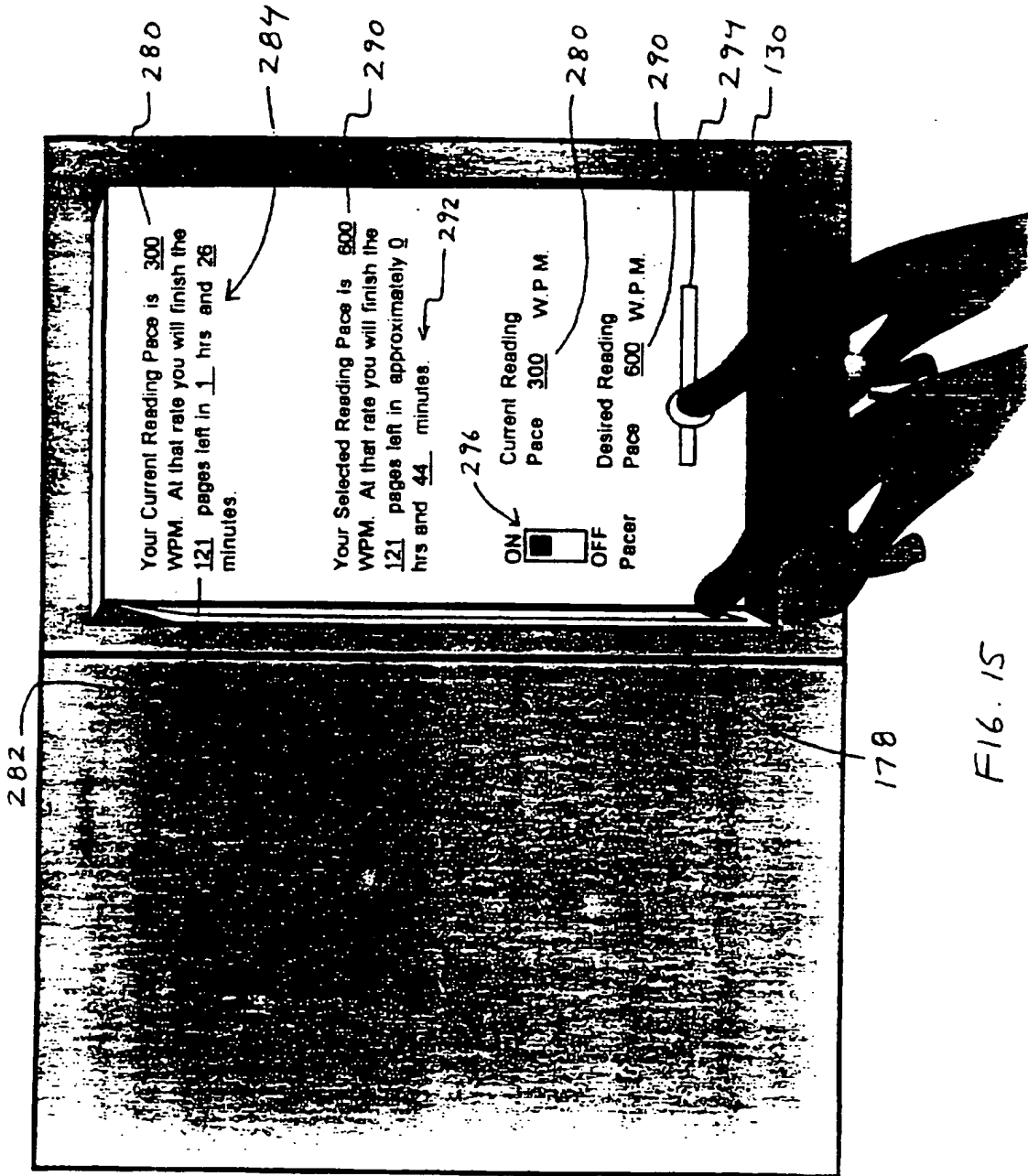

FIG. 14





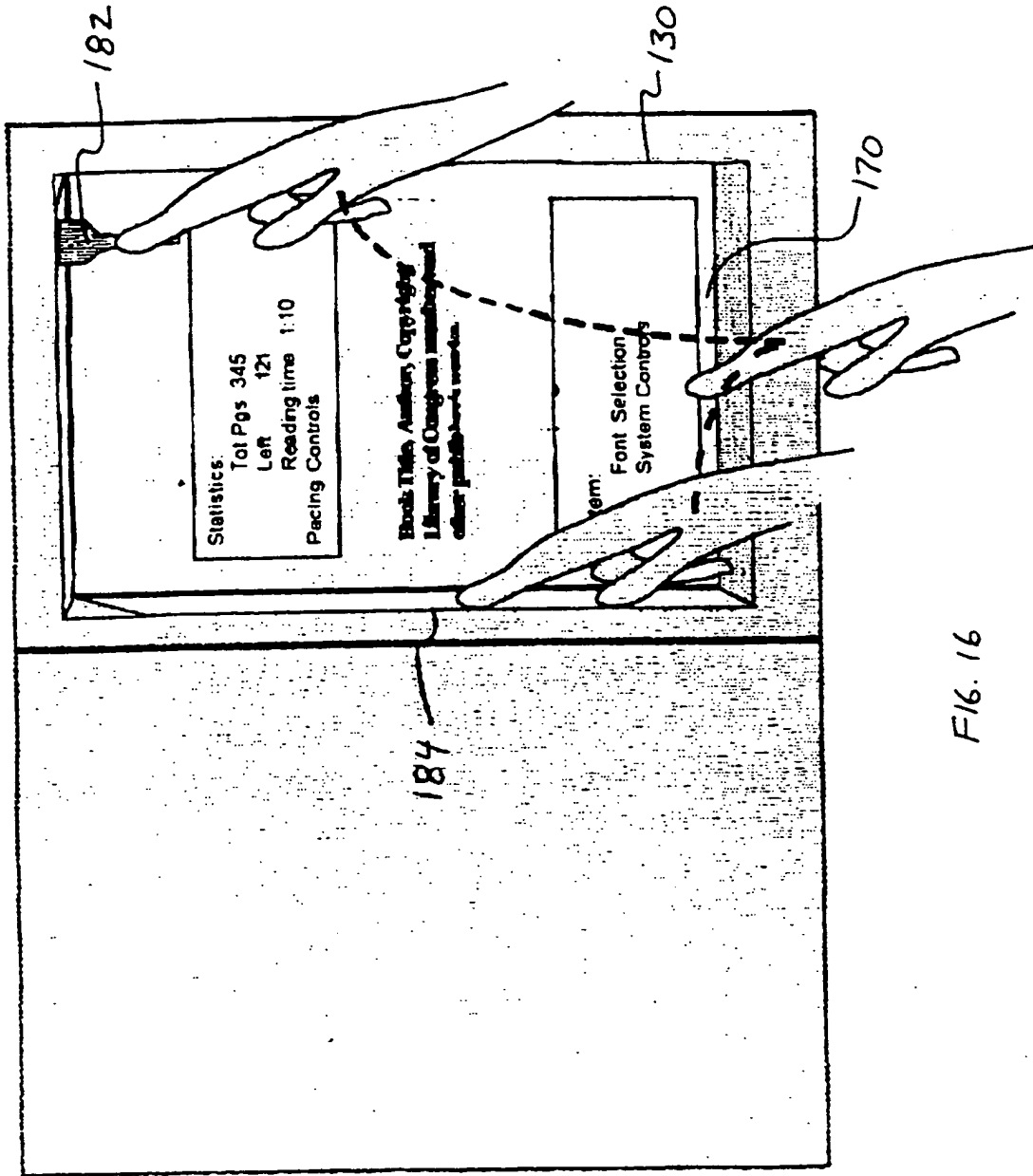

FIG. 16

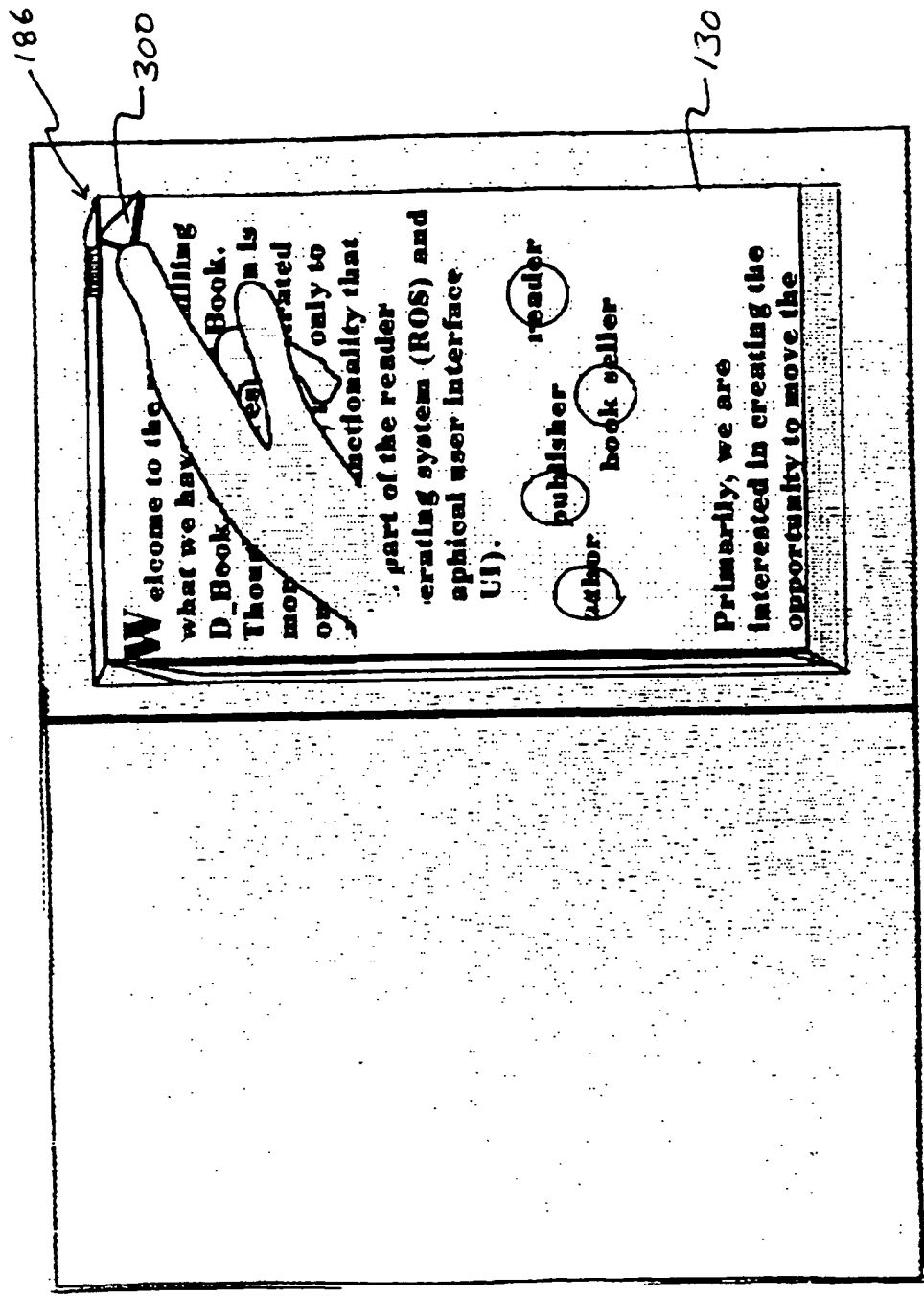

FIG. 17

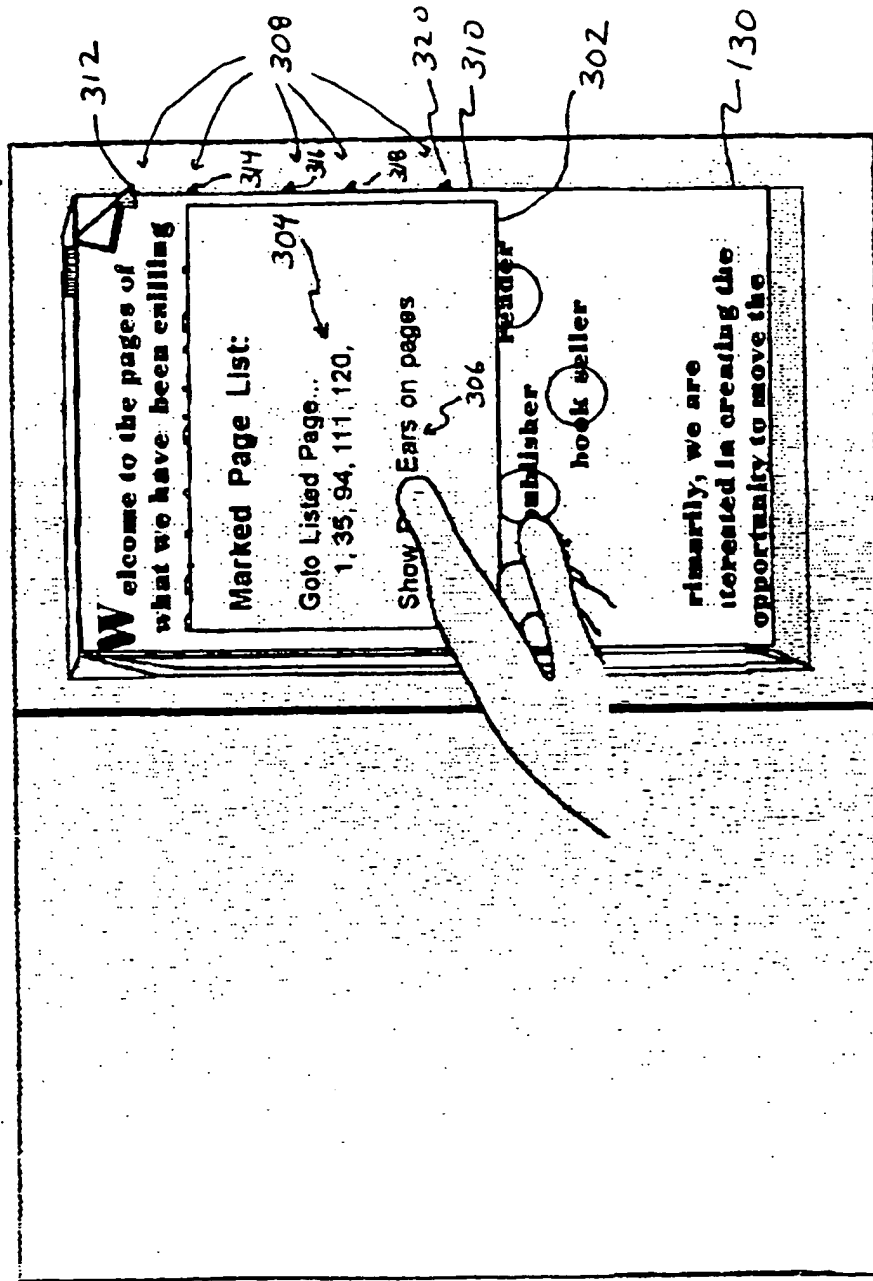
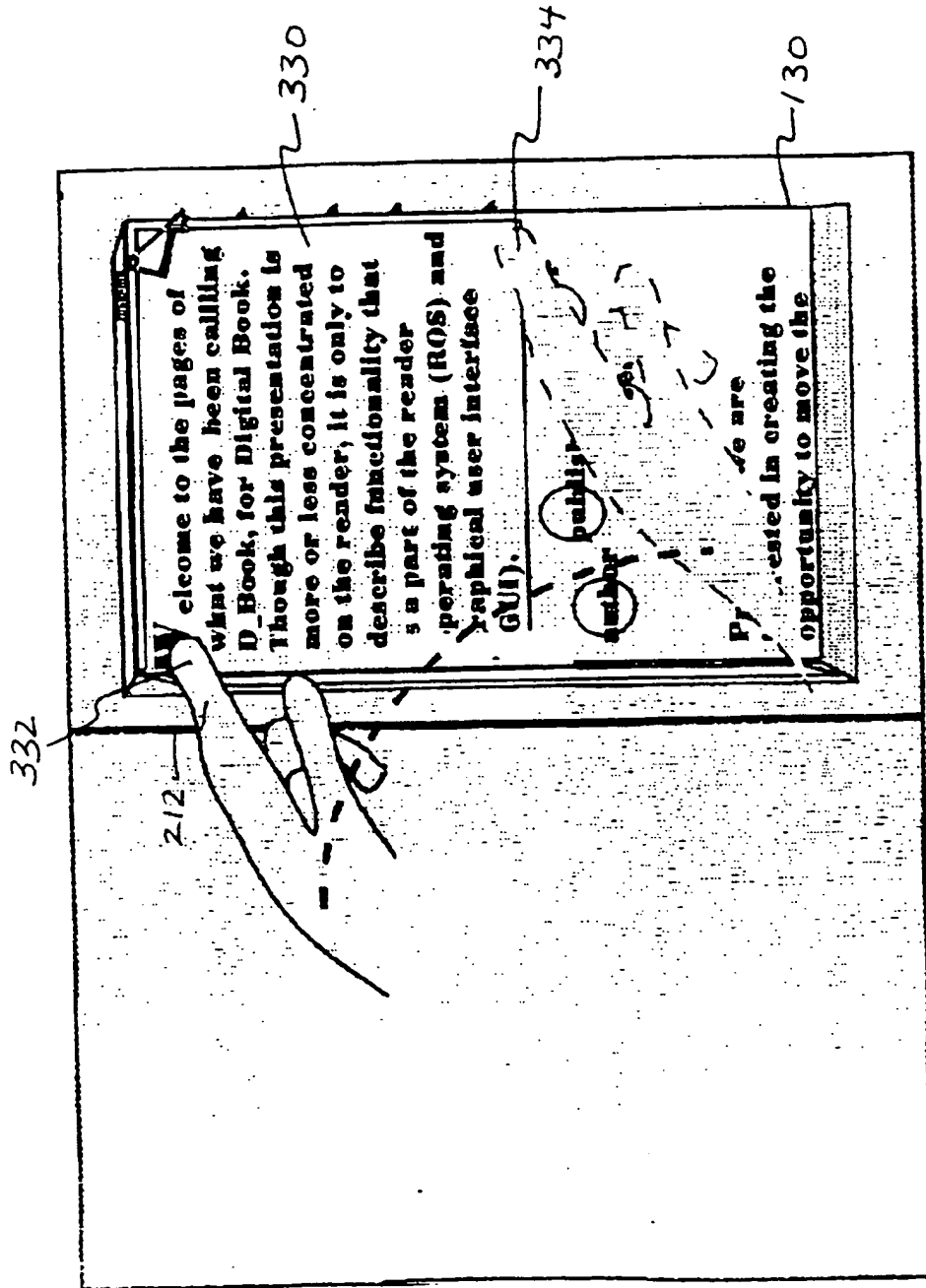

FIG. 18



F16.19

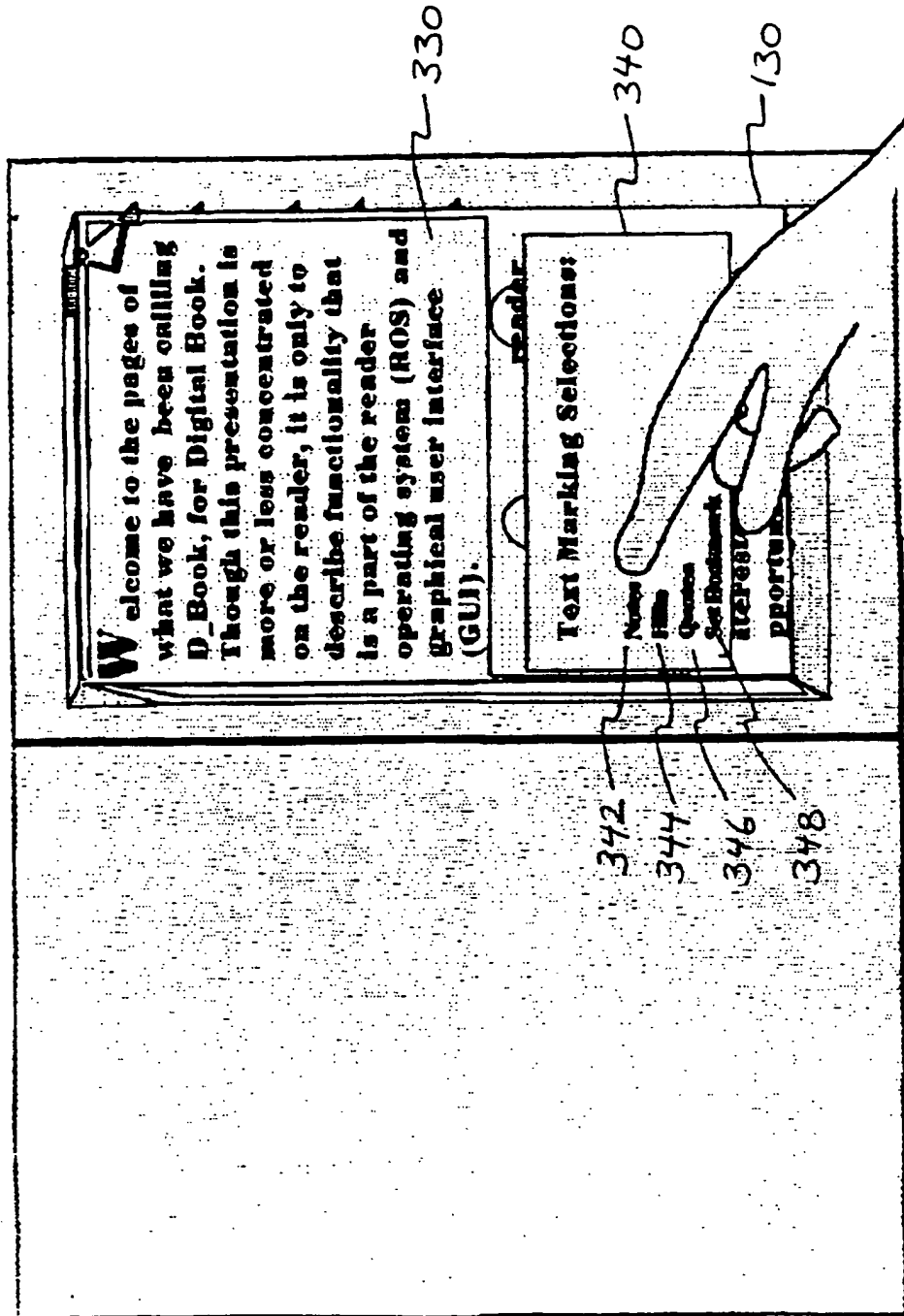

FIG. 20

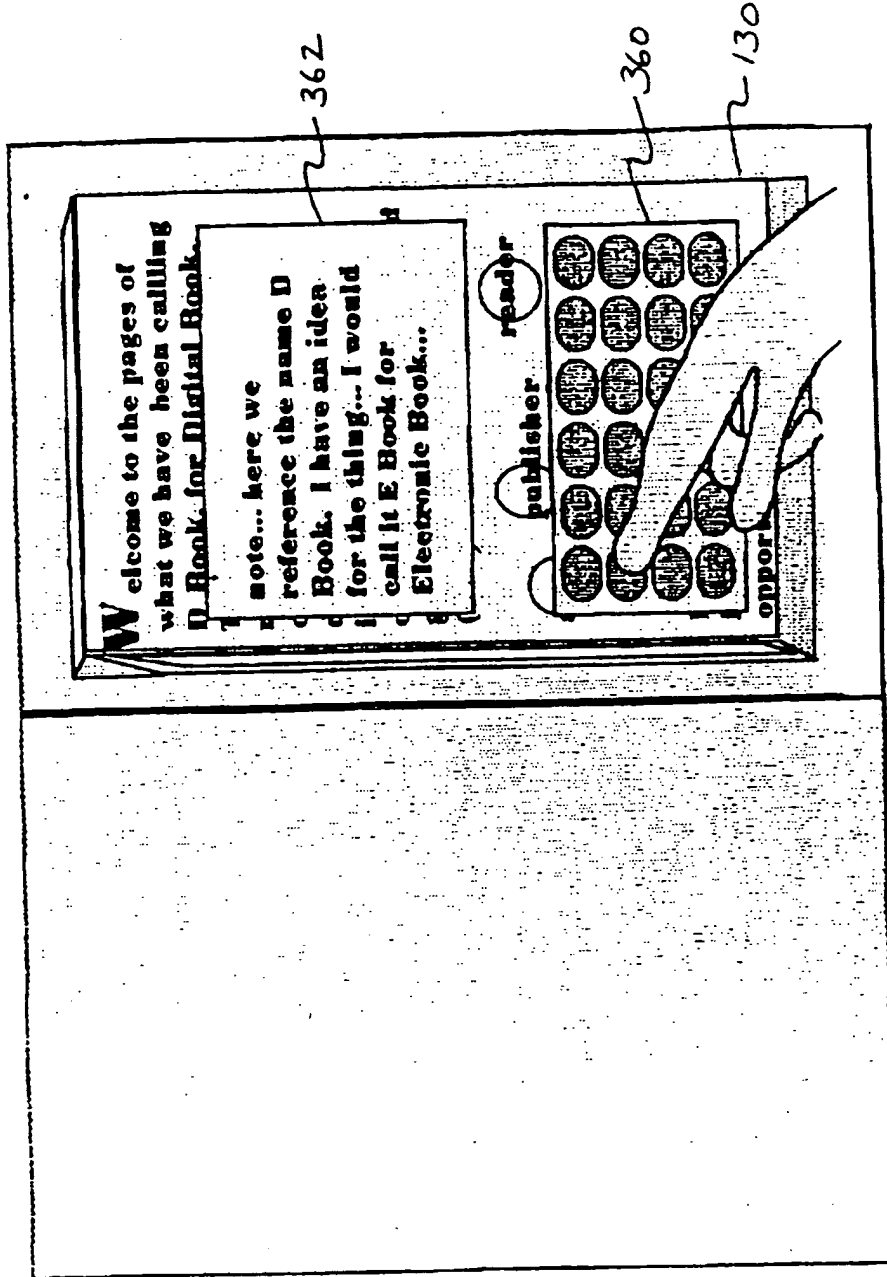

FIG. 21

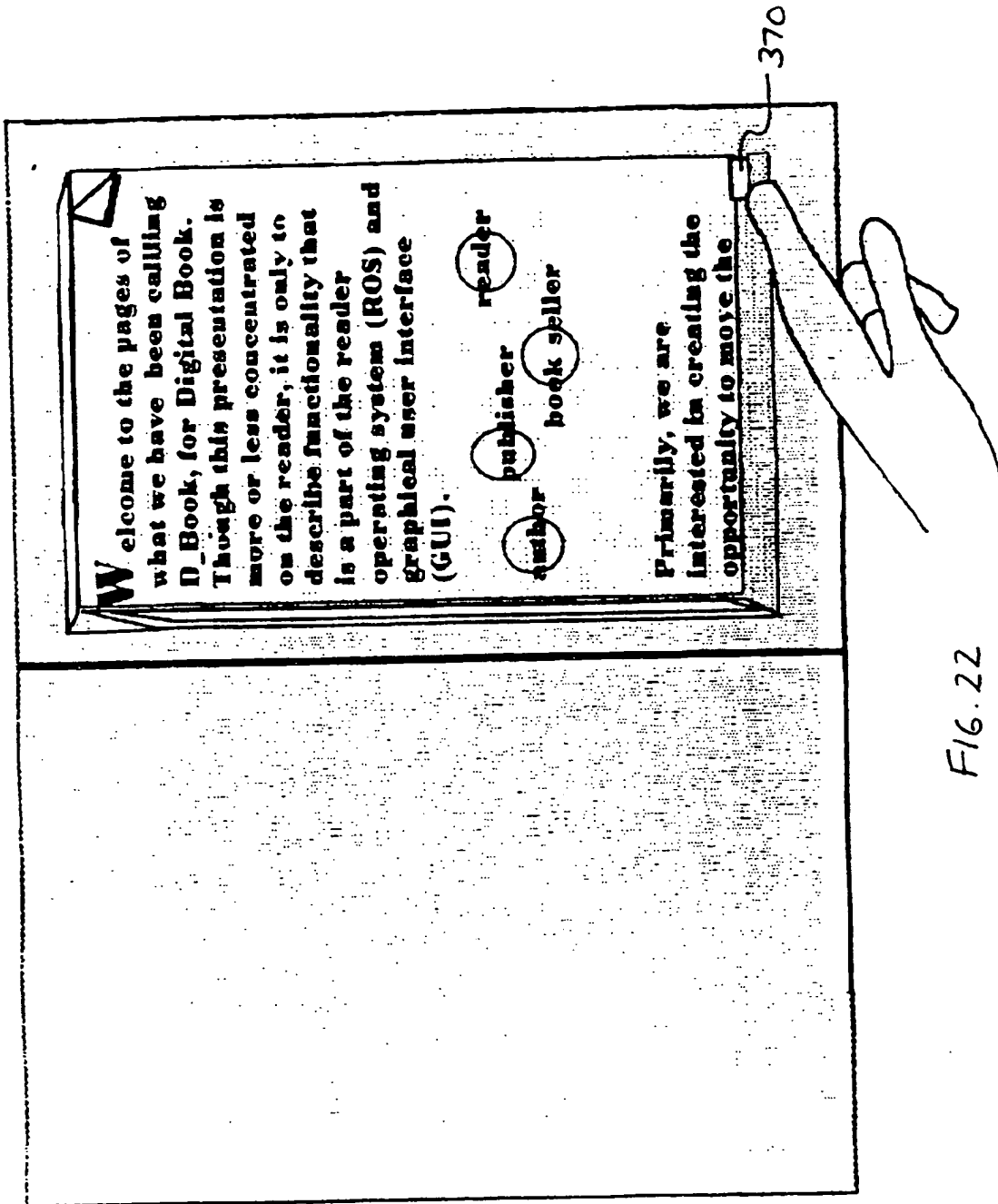
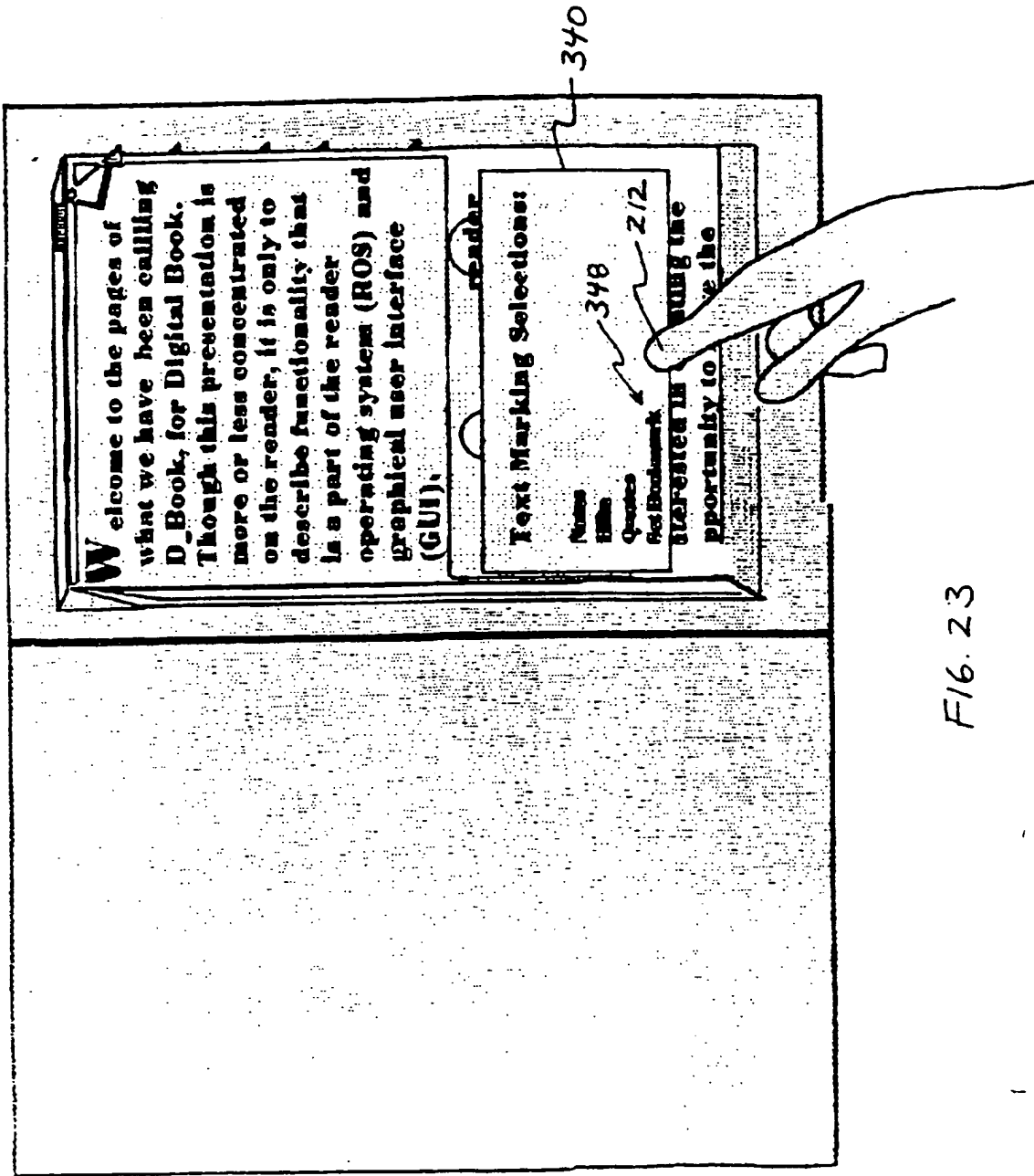

FIG. 22



F16.23



380

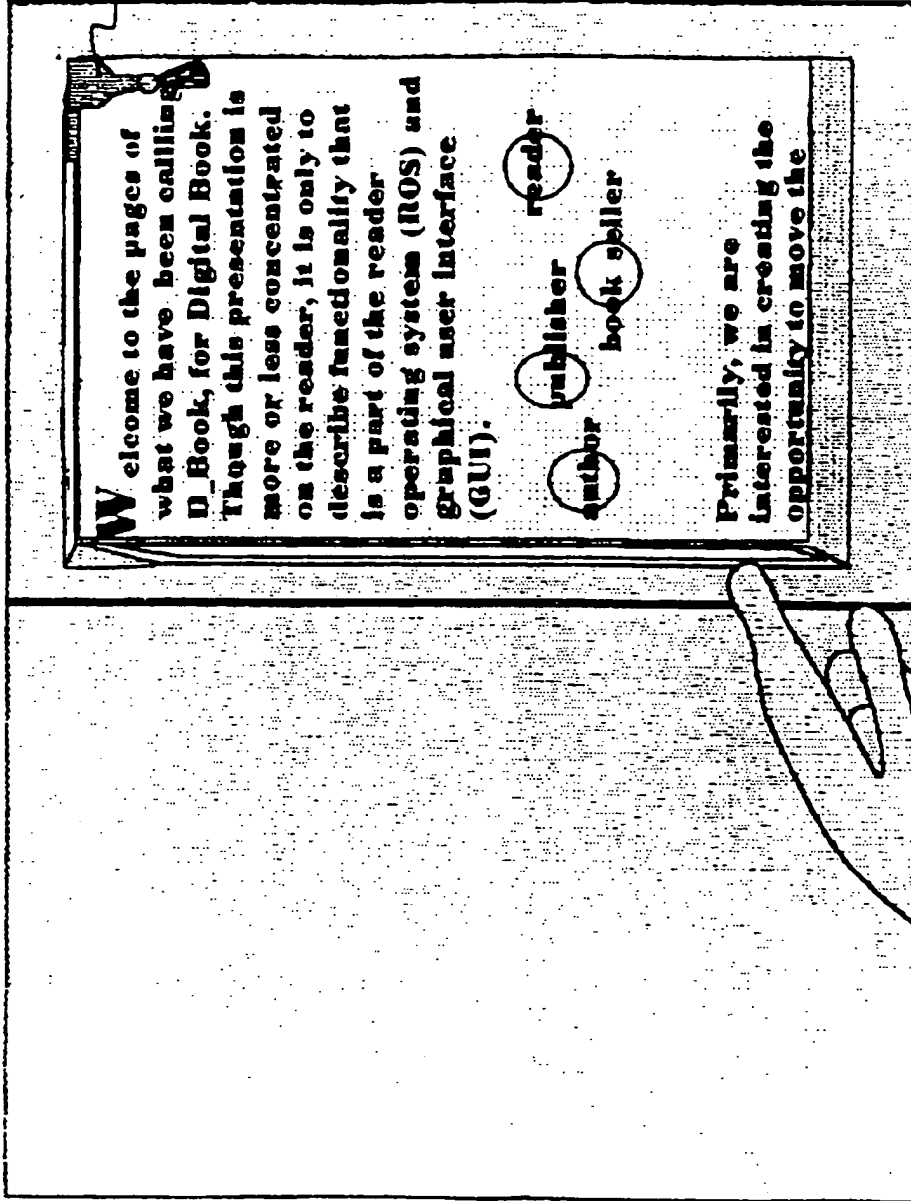

FIG. 24

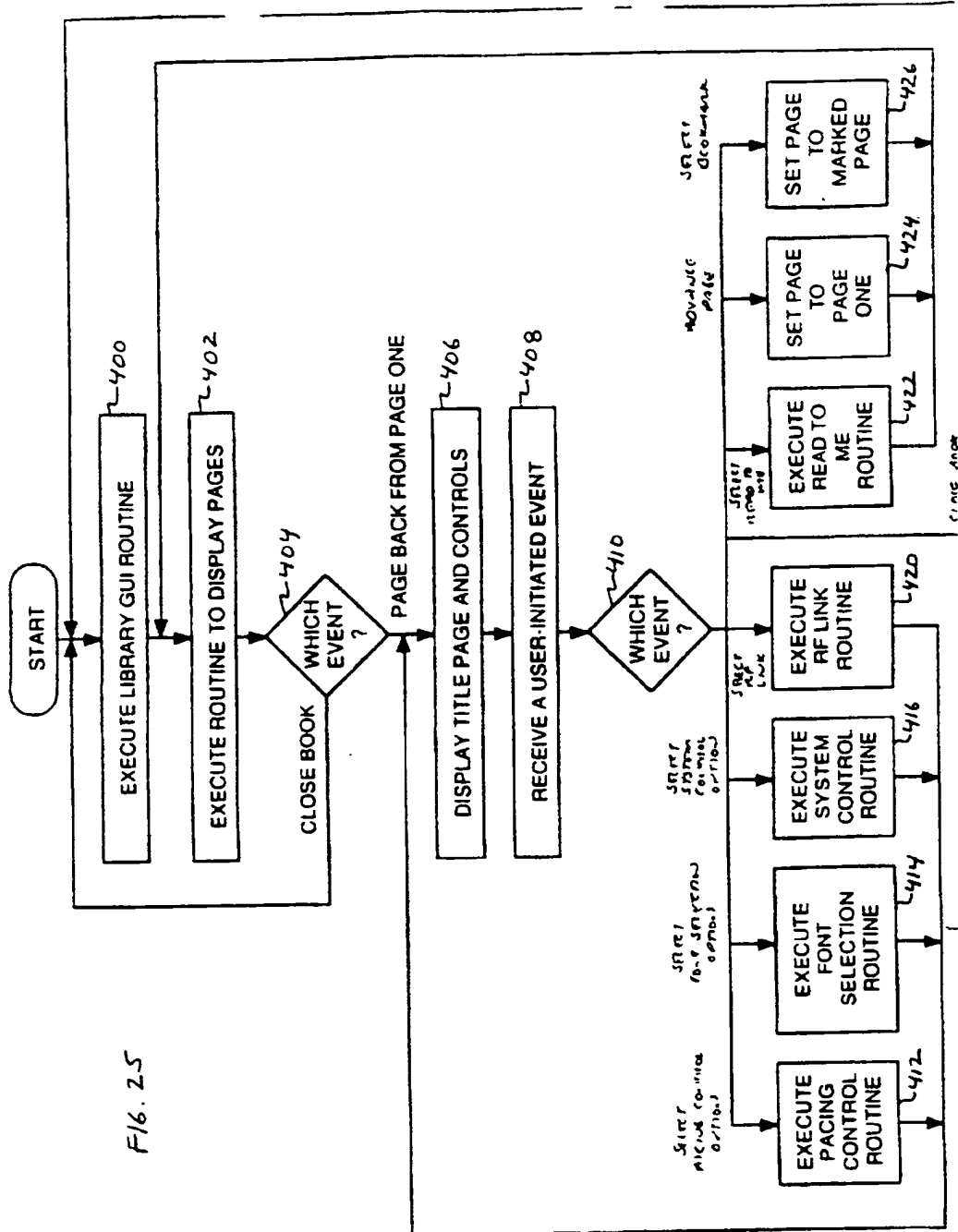

FIG. 25

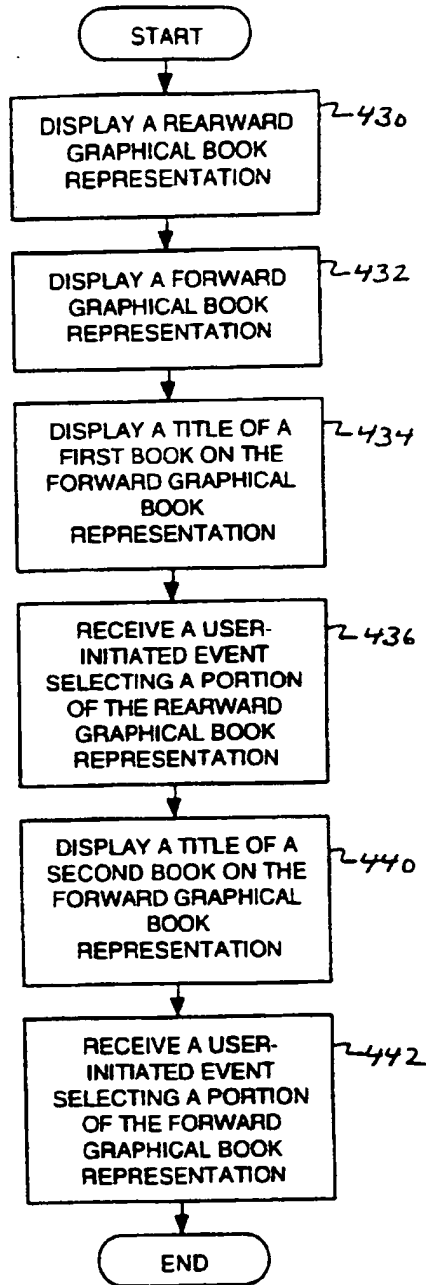

FIG. 26

24/35

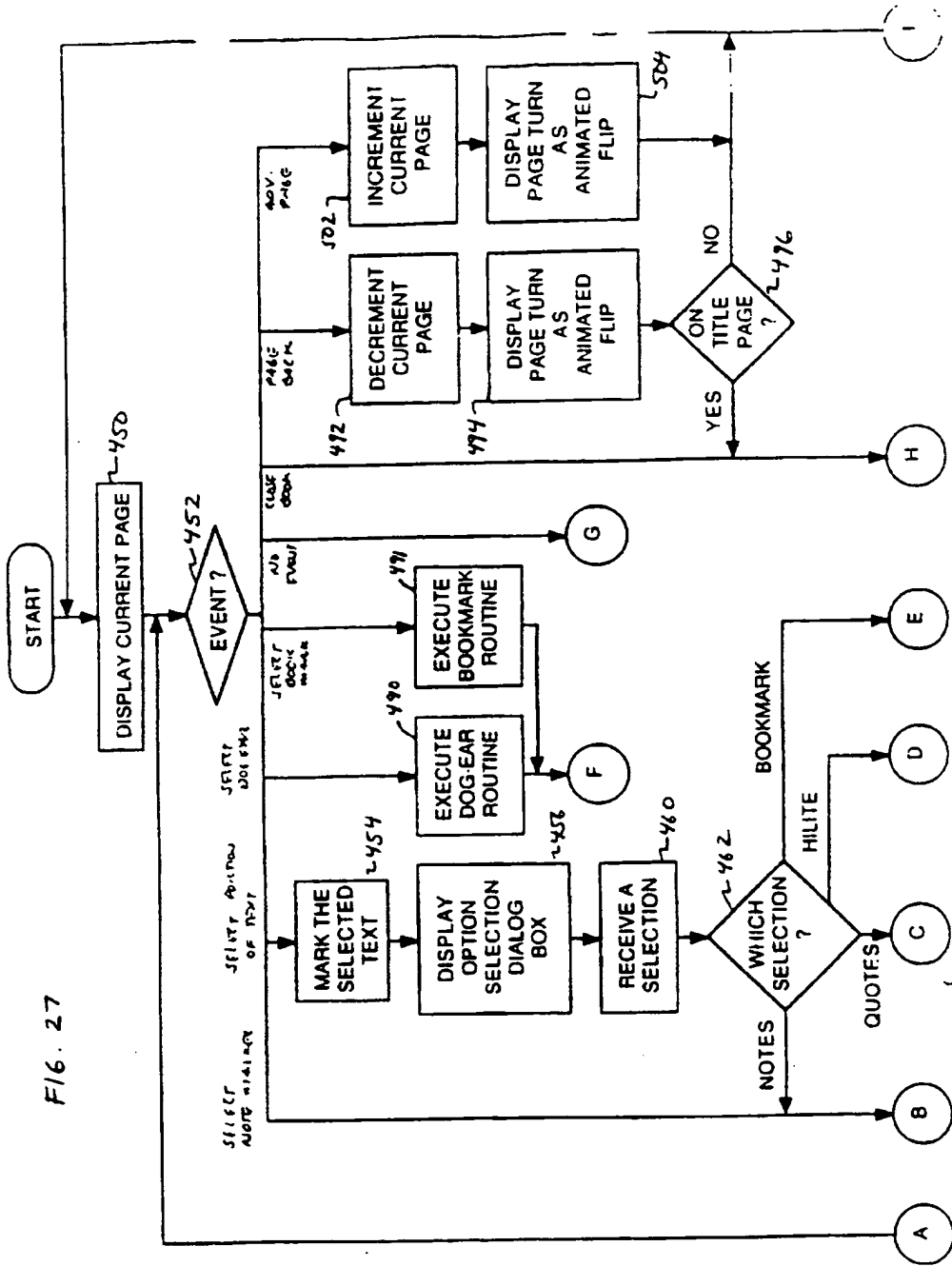

FIG. 27

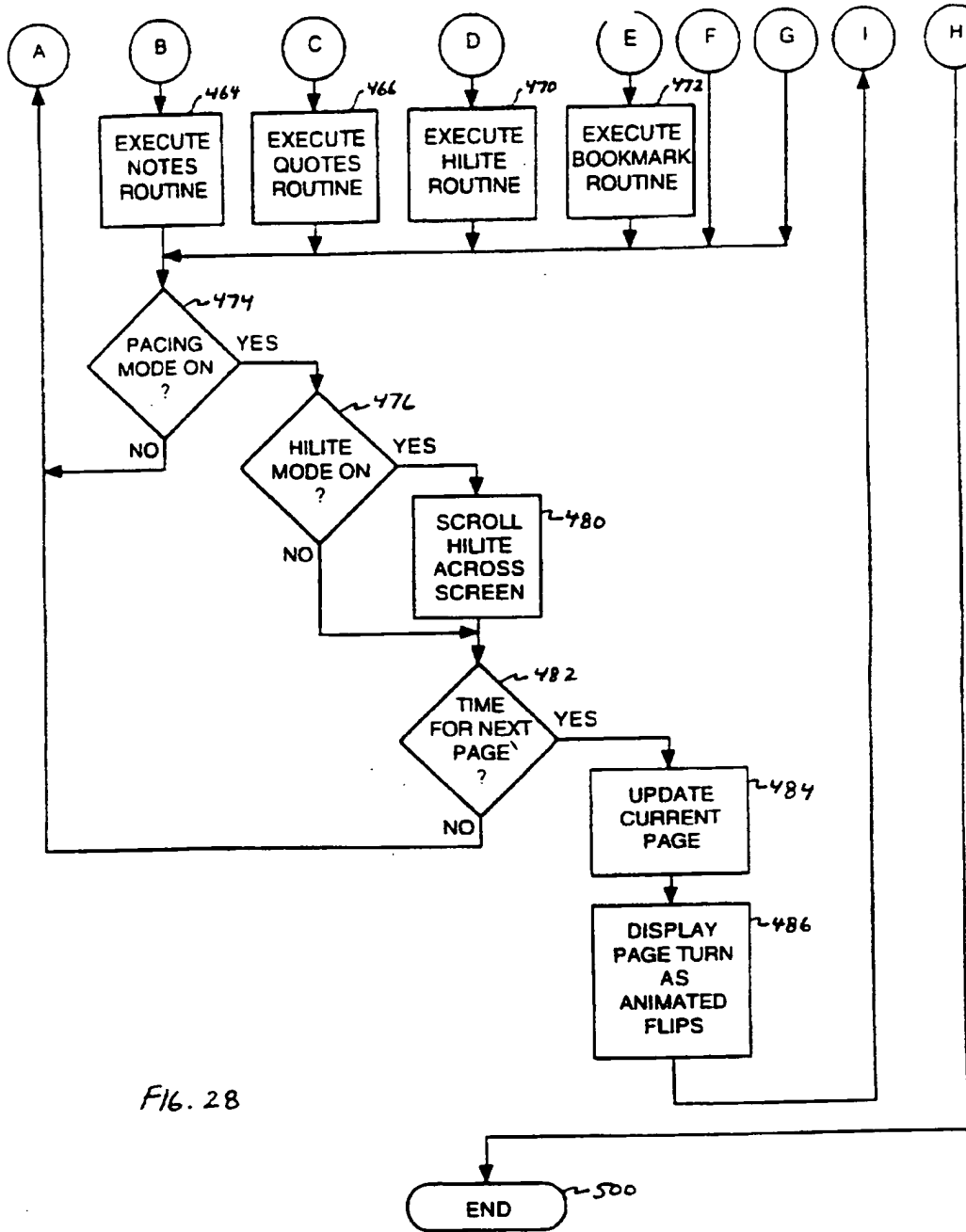
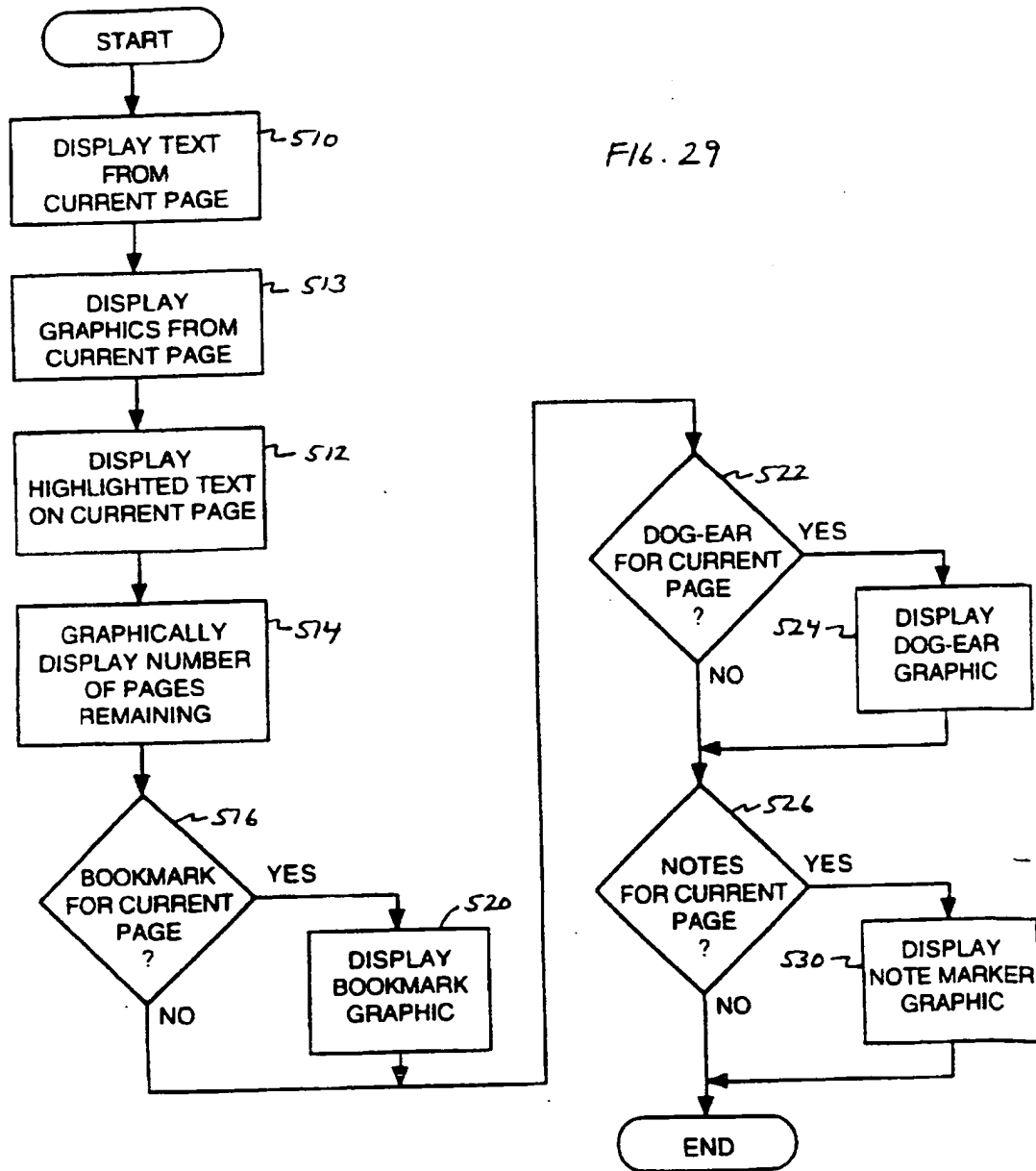
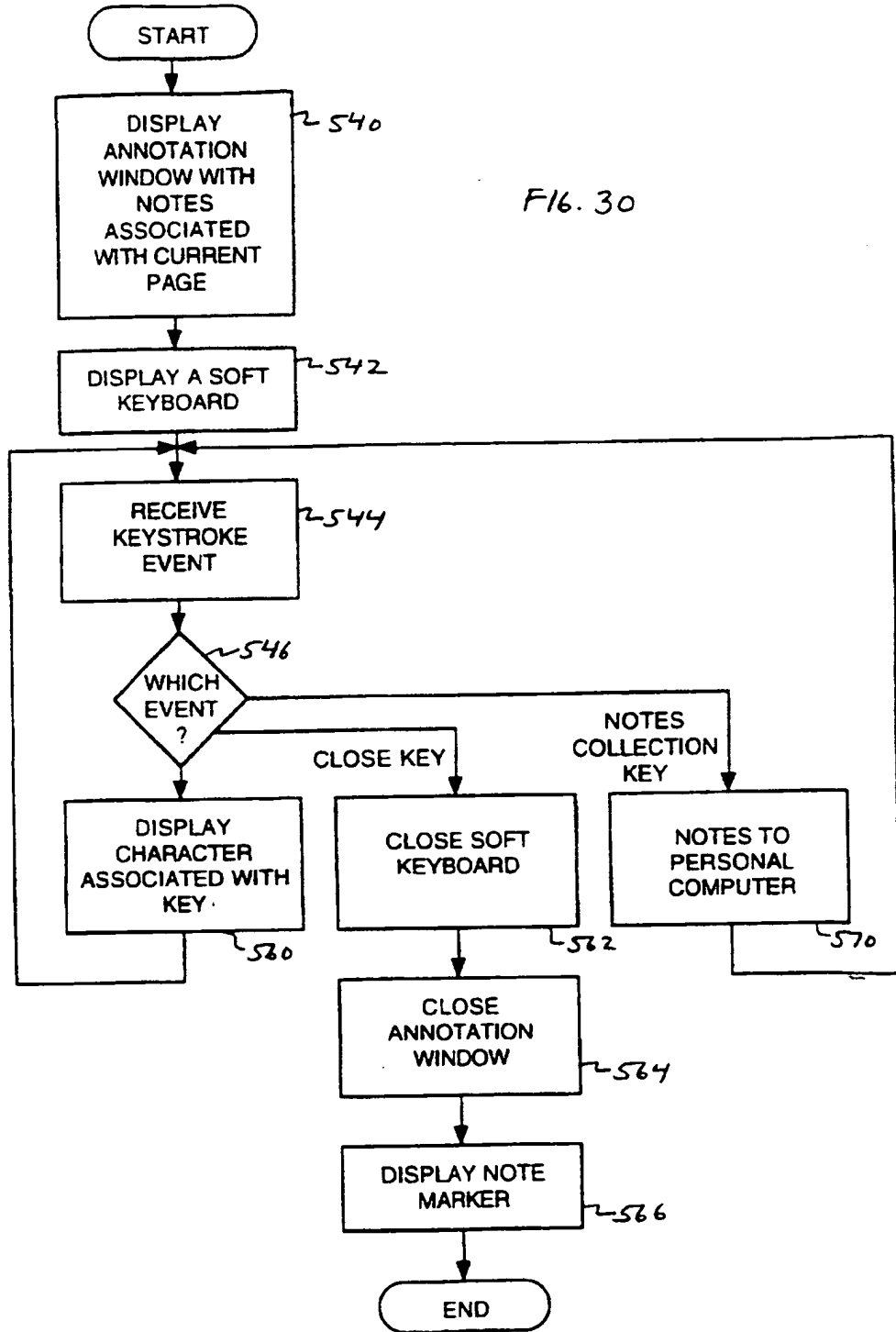

Fig. 28



F16.30



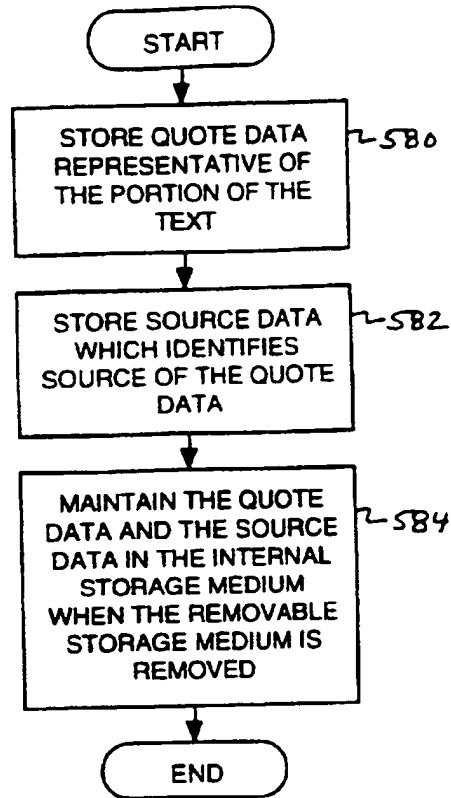
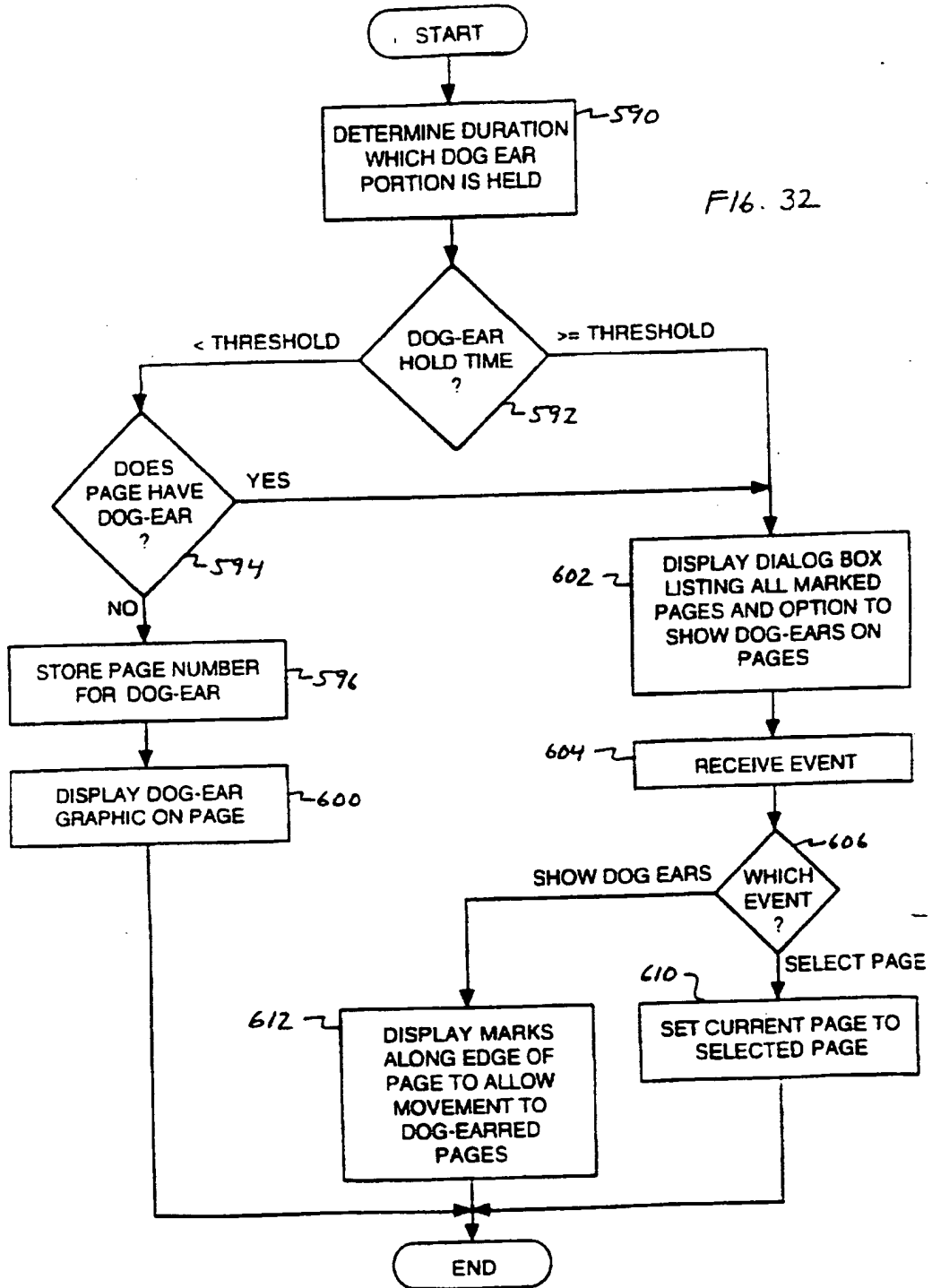

FIG. 31



FIG. 32



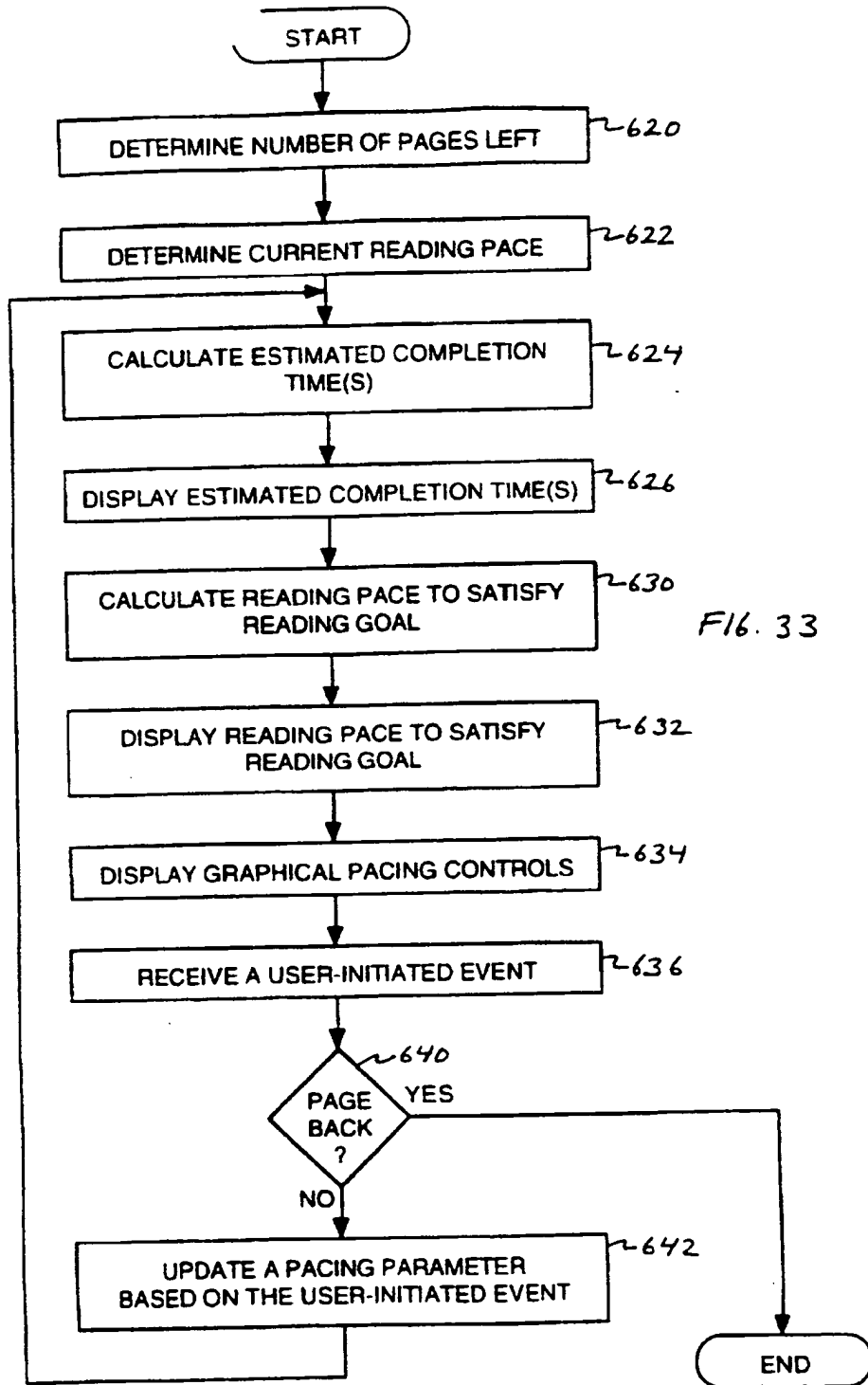
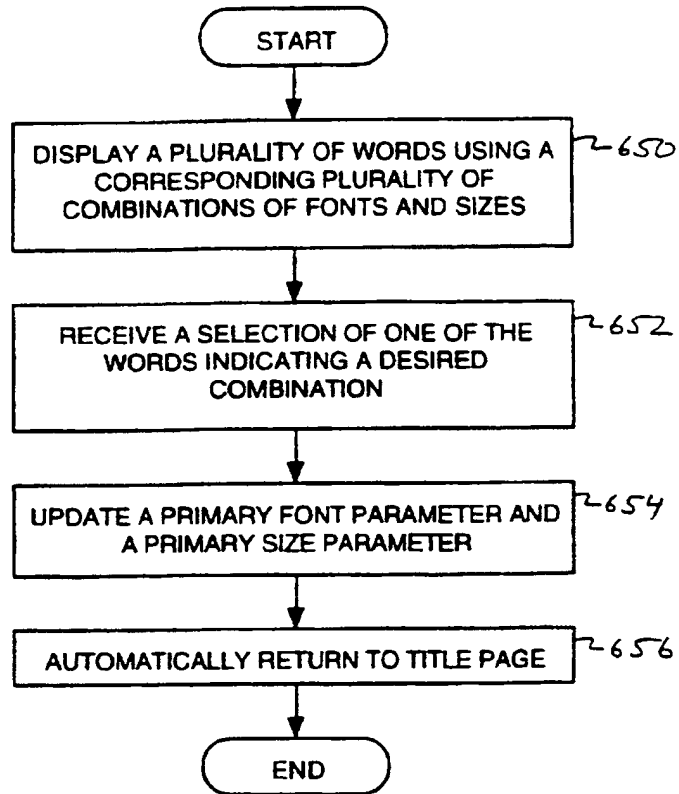
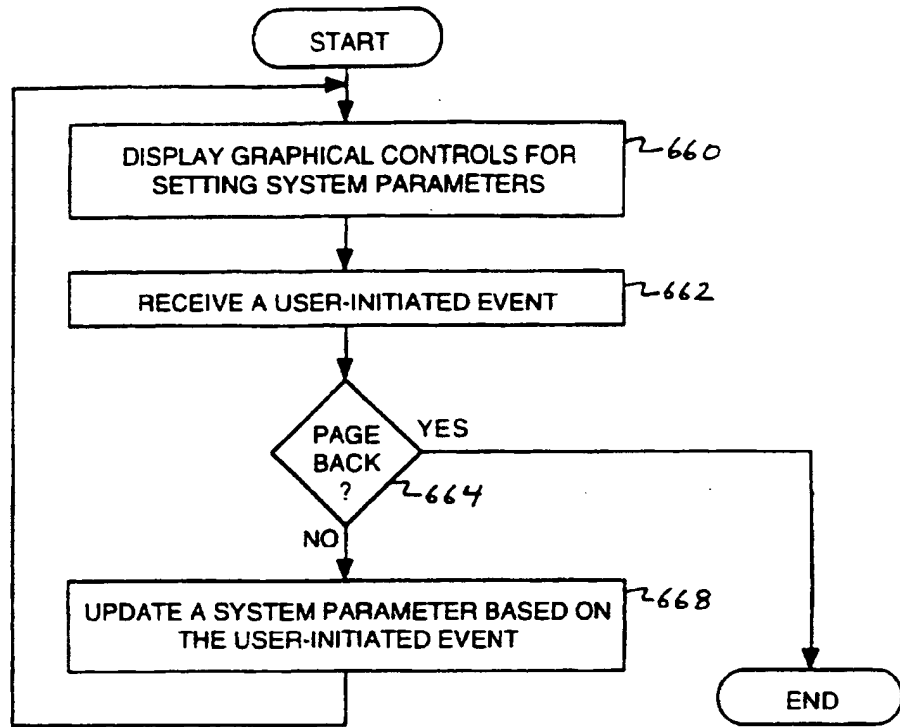

FIG. 33



F16. 34



F16. 35

INTERNATIONAL SEARCH REPORT

International application No.  
PCT/US96/19609

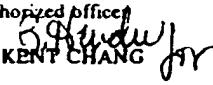
<b>A. CLASSIFICATION OF SUBJECT MATTER</b> IPC(6) : G09G 5/00, 5/22, 5/26; G09B 17/00, 5/00 US CL : 345/173, 143, 128, 901; 434/178, 317 According to International Patent Classification (IPC) or to both national classification and IPC		
<b>B. FIELDS SEARCHED</b> Minimum documentation searched (classification system followed by classification symbols) U.S. : 345/173, 143, 128, 901; 434/178, 317 Documentation searched other than minimum documentation to the extent that such documents are included in the fields searched Electronic data base consulted during the international search (name of data base and, where practicable, search terms used)		
<b>C. DOCUMENTS CONSIDERED TO BE RELEVANT</b>		
Category*	Citation of document, with indication, where appropriate, of the relevant passages	Relevant to claim No.
Y	US 5,475,399 A (BORSUK) 12 December 1995, col.3, lines 43-56.	1-10
Y	US 4,622,546 A (SFARTI et al) 11 November 1986, columns 1-3.	1-10
Y	US 5,475,398 A (YAMAZAKI et al) 12 December 1995, columns 3-4.	1-10
<input type="checkbox"/> Further documents are listed in the continuation of Box C. <input type="checkbox"/> See patent family annex.		
* Special categories of cited documents: *A* document defining the general state of the art which is not considered to be part of particular relevance *E* earlier document published on or after the international filing date *I* document which may throw doubts on priority claim(s) or which is cited to establish the publication date of another citation or other special reason (as specified) *O* document referring to an oral disclosure, use, exhibition or other means *P* document published prior to the international filing date but later than the priority date claimed *T* later documents published after the international filing date or priority date and not in conflict with the application but cited to understand the principle or theory underlying the invention *X* document of particular relevance; the claimed invention cannot be considered novel or cannot be considered to involve an inventive step when the document is taken alone *Y* document of particular relevance; the claimed invention cannot be considered to involve an inventive step when the document is combined with one or more other such documents, such combination being obvious to a person skilled in the art *&* document member of the same patent family		
Date of the actual completion of the international search 18 MARCH 1997		Date of mailing of the international search report 14 APR 1997
Name and mailing address of the ISA/US Commissioner of Patents and Trademarks Box PCT Washington, D.C. 20231 Facsimile No. (703) 305-3230		Authorized officer  KENT CHANG Telephone No. (703) 305-4824